



safety 1st

Grow and Go™

All-in-One Convertible Car Seat

Your model may look different than one shown on cover.

Read all instructions **BEFORE USING** this car seat.

KEEP INSTRUCTIONS FOR FUTURE USE.

 Failure to follow the warnings on the labels and in the instruction manual can result in serious injury or death to your child. Serious injury may include paralysis and/or permanent brain injury.

4358-8497 11.8.23



Welcome to the Safety 1st Family!

Thank you for choosing this car seat, also known as a child restraint!

To help you get started using your child's new car seat, here are the 4 main tasks you'll need to complete.

1

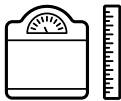

**Measure
Your Child**

2



**Adjust Car Seat to
Fit Your Child**

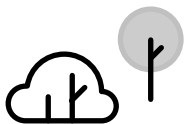

3



**Install Car Seat
into Your Vehicle**



4



**Secure Your Child
in Car Seat**



Your child's safety is worth the time it will take to read and follow these instructions.

Ready? Let's go!

Pages 1-4 will introduce you to the parts of the car seat.

The Back Cover of this Manual has our contact information.

If at any point you would like assistance, please feel free to reach out to us.

Contents

- 1 Getting Started**

 - 1 Parts of Car Seat
 - 3 Accessory Use
 - 5 Choosing Car Seat Mode

- 7 Rear-Facing Section**

 - 9 Rear-Facing Child Fit
 - 11 Rear-Facing Vehicle Install

- 18 Forward-Facing Section**

 - 20 Forward-Facing Child Fit
 - 22 Forward-Facing Vehicle Install

- 29 Securing Child in Car Seat**

- 32 Booster Seat Section**

 - 34 Storing Harness System
 - 37 Booster Seat Use in Vehicle
 - 40 Booster Seat Child Fit

- 41 Making Adjustments to Car Seat**

 - 41 Changing Headrest/Harness Height
 - 42 Changing Buckle Position
 - 44 Harness System Adjustments for Smaller Infants
 - 49 Reclining Car Seat

50 Wash & Care

- 50 Removing Seat Pad Set**
- 52 Cleaning Parts of Car Seat & Installing Seat Pad Set**

53 LATCH & Vehicle Belt Information

- 53 LATCH: Lower Anchor Belt**
- 55 Vehicle Belts**
- 59 Top Tether**

60 Safety Information

- 60 Child Restraint Use**
- 61 Vehicle Seating Position**
- 62 Installation in Vehicle**
- 63 Replacement & Expiration**
- 64 Registration & Safety Notices**
- 65 Aircraft Information**

66 Warranty

©2023 Dorel Juvenile Group, Inc. Safety 1st™ and the Safety 1st logo and design are trademarks of Dorel Juvenile Group, Inc. (800) 544-1108 www.safety1st.com. Styles and colors may vary. Los estilos y los colores pueden variar. Made in USA. Hecho en EE.UU. Distributed by (distribuido por) Dorel Juvenile Group, Inc., 2525 State St., Columbus, IN 47201-7494. Dorel Juvenile Canada, 2233 Argentia Road, Suite 110, Mississauga, ON L5N 2X7. Representante exclusivo en Chile: DOREL JUVENILE CHILE S.A. Av. del Parque 4161, oficina 602 A, Huechuraba, Santiago, Chile - Fono: 56 2 24971500 - www.infanti.cl - www.dorel.cl. Importado y distribuido en Perú por: COMEXA COMERCIALIZADORA EXTRANJERA S.A. SUCURSAL DEL PERÚ - Los Libertadores 455, San Isidro, Lima 27, Lima, Perú RUC 20431062870 – Fono: 4413029 – www.infanti.com.pe. En Centro América, Caribe y Ecuador por: Best Brands Group S.A. – Av. Balboa, Bay Mall Plaza, Planta Baja, local 9, Panamá. - Fono: (507) 300 2884. En Colombia por: Baby Universe S.A.S. - Vía 40 No. 77-29, Barranquilla, Colombia - Fono: (575) 353 1110 Importador: DJGM, S.A. DE C.V. Gabriel Mancera No. 1041 Col. Del Valle, Benito Juárez C.P. 03100 México, Ciudad de México R.F.C. DJG140305GN9 Tel. (55) 67199202



Parts of Car Seat

1

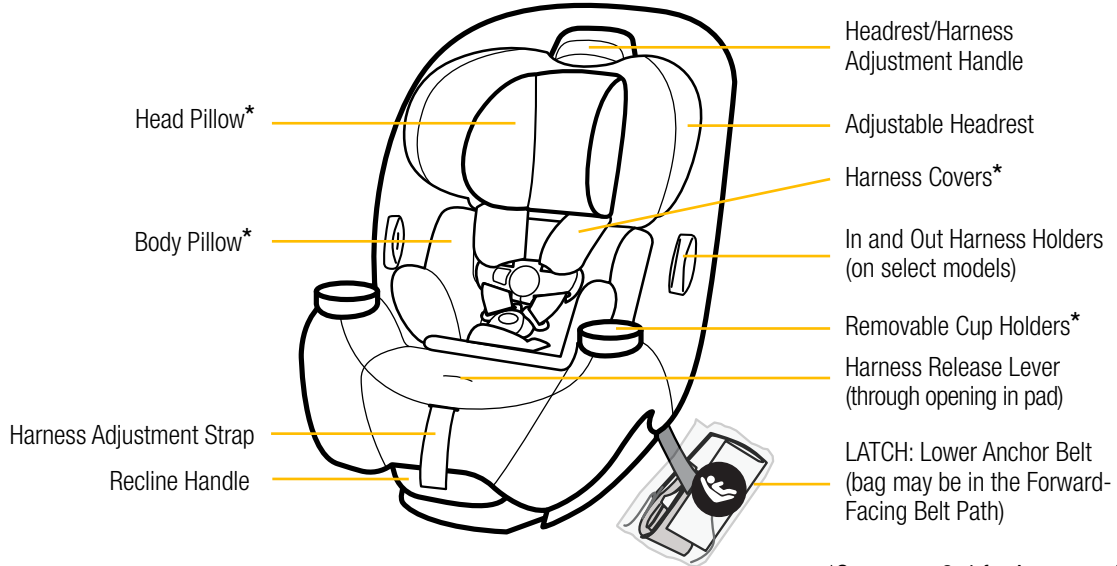

Your model may look different than one shown.

*See pages 3-4 for Accessory Use.

Harness System

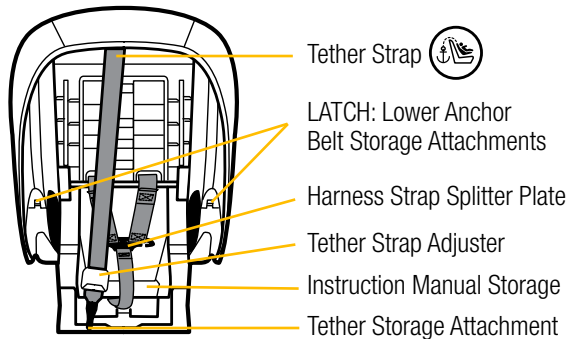
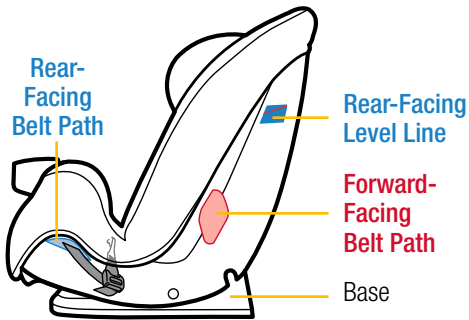
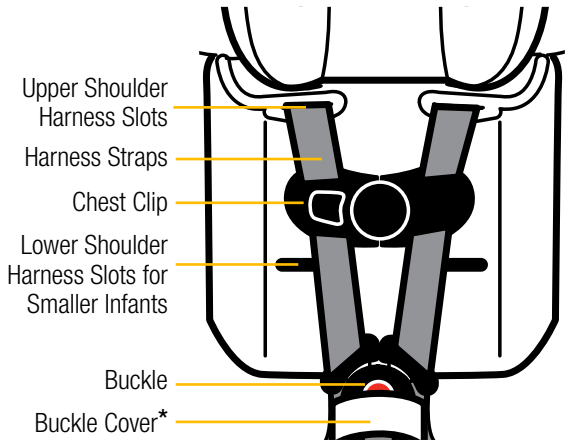

*See pages 3-4 for Accessory Use.

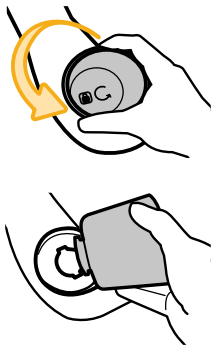

Removable Cup Holder(s)
(on select models)

For Use in All Modes

The cup holder(s) is top-rack dishwasher safe.

To remove cup holder, twist the cup holder counterclockwise. Pull it out of the slot in the car seat.



Head Pillow & Body Pillow
(on select models)

**Only For Use in
Rear-Facing Mode**

The head and body pillows **MUST** be used together.

To remove head pillow, from the back of the head pillow gently pull the fabric tabs out of the headrest pad.

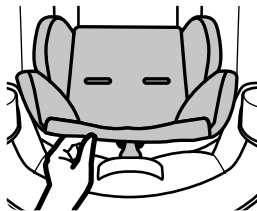

To remove body pillow, undo the buckle and pull it through the slot in the pillow. Slide the pillow out from behind the harness straps.

If using the lower shoulder harness slots for smaller infants, see page 44-47.

To rethread harness for upper harness slots, see page 48.

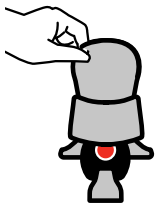

Buckle Cover

(on select models)

For Use in **Rear-Facing Mode** or **Forward-Facing Mode**

To remove, undo the buckle and pull the buckle cover off the buckle.

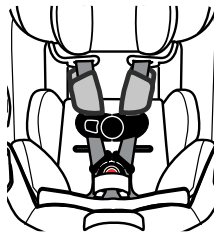

Harness Covers

(on select models)

For Use in **Rear-Facing Mode** or **Forward-Facing Mode**

The harness covers help provide comfort to your child's neck.

If the harness covers will not allow proper positioning of the chest clip or interfere with getting a tight enough harness fit for a smaller infant, remove and do not use.

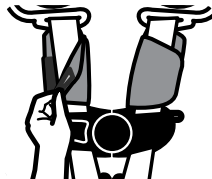

Store until your child is large enough to use the harness covers while maintaining a properly fitting harness.

To remove, pull the fastening strips apart and pull the harness covers off of the harness straps.

WARNING:

Failure to follow these instructions may result in serious injury or death to your child. Serious injury can include paralysis and/or permanent brain injury.

Be certain to measure your child's weight and height (do not guess) before choosing this car seat's mode.

Your child's height, weight, and age determine how the car seat should be placed in the vehicle.

Children vary widely in body size, shape, and temperament—**please consult your doctor before switching between any modes within the limits and fit requirements of the car seat.**

Infants and Toddlers

Must use the seat in rear-facing mode as long as possible, which is until the child reaches the maximum weight or height limit for rear-facing mode.

Toddlers and Preschoolers

Once they are facing forward, the child must use the seat in forward-facing mode with a harness for as long as possible, which is until the child reaches the maximum weight or height limit for forward-facing mode.

School-Aged Children

Once they have outgrown their forward facing car seat, the child must use a belt-positioning booster seat until the vehicle's lap and shoulder seat belt fit properly.

If you have any questions regarding the proper mode for your child, please see the back cover of this manual for our contact information.



Rear-Facing Mode

5-40 lb (2.3-18 kg) and
19-40 in. (48-101.6 cm)

Children under 1 year of age **MUST** ride **Rear-Facing** and your child **MUST** remain **rear-facing** until they outgrow any one of the above.

Rear-Facing Section PAGE 7

Rear-Facing Child Fit PAGE 9

Rear-Facing Vehicle Install
PAGE 11



Forward-Facing Mode

22-65 lb (10.1-29 kg) and
29-49 in. (73.6-125 cm)

Forward-Facing Section
PAGE 18

Forward-Facing Child Fit
PAGE 20

Forward-Facing Vehicle Install
PAGE 22



Booster Seat Mode

40-100 lb (18.1-45.4 kg) and
43-52 in. (110.1-132.1 cm)

Booster Seat Section
PAGE 32

Storing Harness System
PAGE 34

Booster Seat Use in Vehicle
PAGE 37

Booster Seat Child Fit
PAGE 40

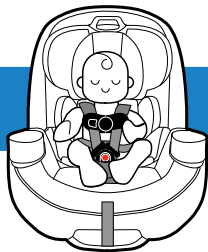

5-40 lb (2.3-18 kg) and 19-40 in. (48-101.6 cm)

Children under 1 year of age **MUST** ride **Rear-Facing** and your child **MUST** remain **rear-facing** until they outgrow any one of the following:

- **Weight Limit:** 40 lb (18 kg); **OR**
- **Height Limit:** 40 in. (101.6 cm); **OR**
- **Rear-Facing Child Fit** requirements, see page 9.

Before installing the car seat in your vehicle, check your child's fit in the car seat.

This way you won't have to redo the vehicle installation to make adjustments to the car seat.

Rear-Facing Child Fit: Page 9

Rear-Facing Vehicle Install: Page 11

WARNING:



NEVER install a rear-facing child restraint in the front seat of a vehicle equipped with an active frontal airbag.

DO NOT use the tether for rear-facing mode. Secure the tether strap hook to its storage attachment.

DO NOT use the lower anchor belt along with the vehicle lap or lap/shoulder belt.

DO NOT fasten multiple lower anchor hooks on the same lower anchor bar in the vehicle.

Check the vehicle belt or the lower anchor belt before each use.

Use **ONLY** if the belt can be tightened properly and locked securely in place.

Even when unoccupied, this child restraint **MUST** be firmly secured to the vehicle with the lower anchor belt or with the vehicle seat belt.

This child restraint **MUST ALWAYS** face the rear of the vehicle until the child has reached the maximum weight or height limit for the rear-facing mode.

1

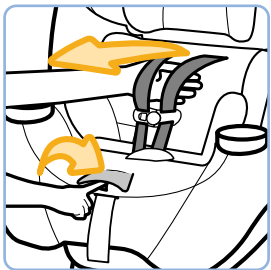

Fully Loosen Harness Straps

Push down on the harness release lever (through the opening in the pad) while pulling out on the harness straps as shown.

2

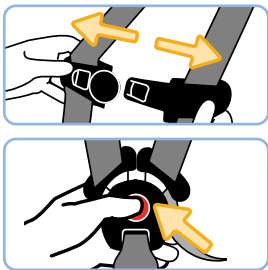

Undo Chest Clip & Buckle

It may be easier to undo the buckle by pressing in towards the top of the button.

3

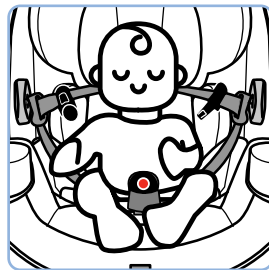

Place Child in Car Seat

On select models: You may use the In and Out Harness Holders to place the harness straps out of the way.

Your child's bottom and back should be flat against the car seat.

4

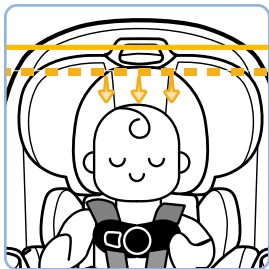

Check Head Position

The top of your child's head **MUST be at least 1 in. (2.5 cm) below** the top of the car seat's headrest.

5

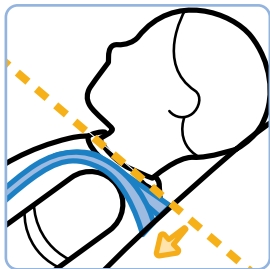

Check Harness Strap Position

The harness strap **MUST be at or slightly below** the shoulders; never above.

6

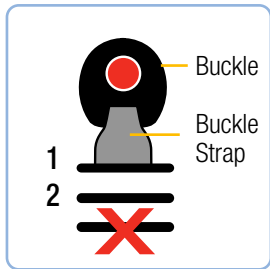

Check Buckle Position

- Use the slot closest to your child.
- The buckle **should not be underneath or behind** your child.

DO NOT use the 3rd buckle slot in **Rear-Facing Mode**.

i

To change the harness strap height, see page 41.

To change the buckle position, see page 42.

To learn how to check harness tightness, see pages 29-30.

If you cannot achieve a snug harness fit for your child, see pages 44-47.



Before installing the car seat in your vehicle, check to see if you need to adjust the buckle position for your child. **See page 9 for child fit.**

Once the car seat is installed, you will not be able to adjust the buckle position.

Review Vehicle Owner's Manual

Determine what kind of vehicle belts your car has and how to use them to lock a car seat in place **OR** where LATCH: lower anchor seating positions are located in your vehicle.

There are 2 different methods for install.

Use only one:

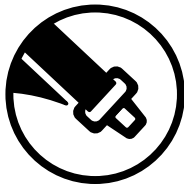

Vehicle Belt



LATCH: Lower Anchor Belt

WARNING:

DO NOT use both the LATCH: lower anchor belt and vehicle belt at the same time to install the car seat.

1

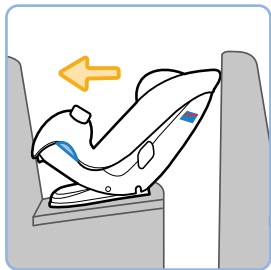

Place Car Seat **Rear-Facing** in Back Seat

The car seat base **MUST** be flat on the vehicle seat.

When using the passenger or driver-side locations, the car seat

MUST be touching the back of the vehicle seat in front of it, or be as close as possible.

2

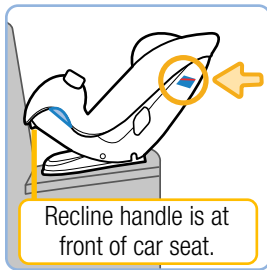

Recline Car Seat & Check **Rear-Facing** **Level Line**

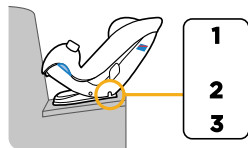

For children **who cannot sit up unassisted**, the **Rear-Facing Level Line** on the car seat **MUST** be parallel with the ground using either **Position 3** or **2**.

For children **who can sit up unassisted**, you may make the car seat more upright in **Position 2**.

continued on next page

3

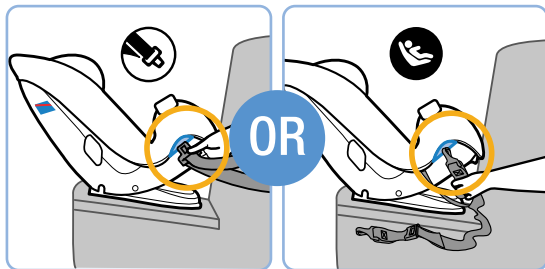

Locate **Rear-Facing Belt Path** & Route Vehicle Belt or Lower Anchor Belt Through It

For the LATCH belt: You may need to fully lengthen the belt before routing it into the belt path. Squeeze the adjuster button and pull the belt out as shown.



4

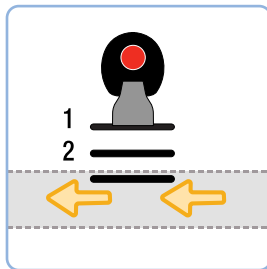

Vehicle Belt or Lower Anchor Belt Goes:

- under the car seat pad; **AND**
- across the car seat; **AND**
- in front of the buckle; **AND**
- out the other **Rear-Facing Belt Path** opening.

DO NOT twist the belt.

i



Adjuster

Finished Lower Anchor Belt Routing

The lower anchor belt adjuster can be on either side of the car seat.

5

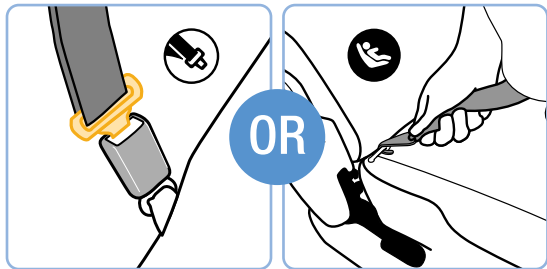

Buckle Vehicle Belt

If your car has a **switchable retractor**, use it to lock the vehicle belt. Review page 57 of this manual or your vehicle owner's manual.

Attach Lower Anchor Belt Hooks to Vehicle's Lower Anchors

6

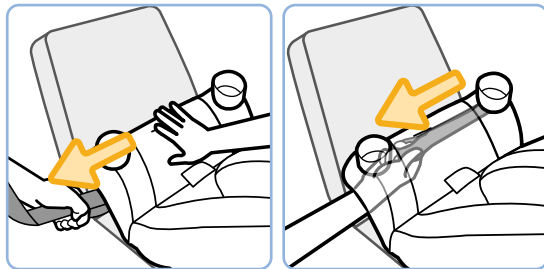

Tighten Belt

Place your hand in the car seat and firmly push the car seat down and back towards the vehicle seat. Pull the belt towards you and parallel (in line) with the belt path as shown.

For the LATCH belt or Lap Only Vehicle Belt: it may be easier to tighten if you route the free end of the belt back into the **Rear-Facing Belt Path**, reach into the **Rear-Facing Belt Path**, and pull the free end of the belt towards you.

continued on next page

7

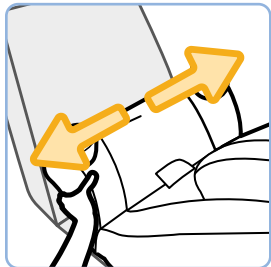

Check Belt Tightness

Hold the **Rear-Facing Belt Path** with your non-dominant hand. Push and pull the car seat from side to side.

The car seat should not move more than **1 in.** (2.5 cm).

i

If the car seat moves more than 1 in. (2.5 cm), you can try:

- Pulling the belt tighter; **OR**
- Reinstalling the car seat; **OR**
- Changing to a different seating location; **OR**
- Switching to a different install method (LATCH or vehicle belt).

8

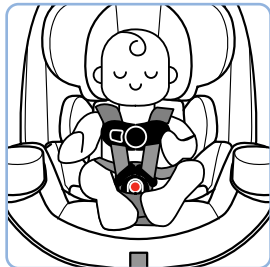

Secure Child in Car Seat

See pages 29-31.

9

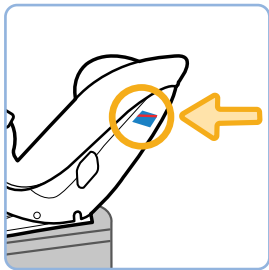

Recheck Rear-Facing Level Line

Redo the installation if the car seat is not reclined correctly for your child. See step 2 and info box on page 12.

i



Only if necessary, you may place a tightly rolled towel(s) or foam pool noodle(s) under the front of the car seat base to help make the **Rear-Facing Level Line** parallel with the ground.

Check often to make sure padding is still in place and the belt is tight.

continued on next page

FINISHED!

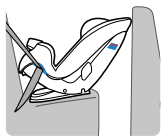

Lap/Shoulder Belt

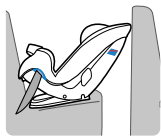

Lap Belt

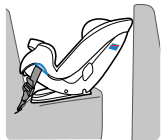

LATCH: Lower Anchor Belt

- ✓ **Vehicle Belt Install:** Is the vehicle belt locked? See step 5.
- ✓ **LATCH: Lower Anchor Belt Install:** Are the hooks securely attached to the vehicle's lower anchors? See step 5.
- ✓ Is the belt tightened enough so that the car seat does not move more than 1 in. (2.5 cm) from side to side? Check the tightness of the install often to make sure it has not loosened. See steps 6 and 7.
- ✓ If your child cannot sit up unassisted, is the **Rear-Facing Level Line** parallel with the ground? See steps 2, 8, 9, and info box on page 16.

When using the passenger or driver-side locations, the car seat **MUST** be touching the back of the vehicle seat in front of it, or be as close as possible.

Forward-Facing Section



22-65 lb (10.1-29 kg) and 29-49 in. (73.6-125 cm)

In this car seat, your child can remain harnessed **Forward-Facing** until they outgrow any one of the following:

- **Weight Limit:** 65 lb (29 kg); **OR**
- **Height Limit:** 49 in. (125 cm); **OR**
- **Forward-Facing Child Fit** requirements, see page 20.

Before installing the car seat in your vehicle, check your child's fit in the car seat.

This way you won't have to redo the vehicle installation to make adjustments to the car seat.

Forward-Facing Child Fit: Page 20

Forward-Facing Vehicle Install: Page 22

 **WARNING:**

DO NOT use the lower anchors of the child restraint anchorage system (LATCH system) to attach this child restraint when restraining a child weighing more than 40 lbs (18 kg).

The vehicle belt **MUST** be used for installation if your child weighs more than 40 lb (18 kg).

When anchors are available, you **MUST ALWAYS** attach, adjust, and secure the tether (top anchorage) strap when installing the car seat in the Forward-Facing Mode with internal harness.

DO NOT use the lower anchor belt along with the vehicle lap or lap/shoulder belt.

Check the vehicle belt or the lower anchor belt before each use.

Use **ONLY** if the belt can be tightened properly and locked securely in place.

DO NOT fasten multiple lower anchor hooks on the same lower anchor bar in the vehicle.

Even when unoccupied, this child restraint **MUST** be firmly secured to the vehicle with the lower anchor belt or with the vehicle seat belt.

Before using this seat in forward-facing mode, your child must have outgrown the seat in rear-facing mode.

Forward-Facing Child Fit

1

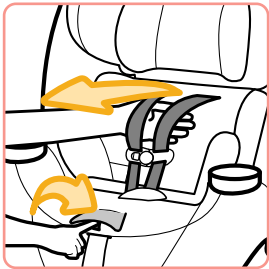

Fully Loosen Harness Straps

Push down on the harness release lever (through the opening in the pad) while pulling out on the harness straps as shown.

2

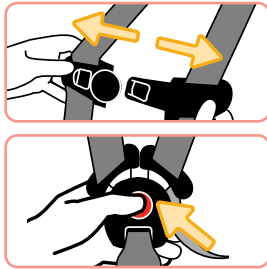

Undo Chest Clip & Buckle

It may be easier to undo the buckle by pressing in towards the top of the button.

3

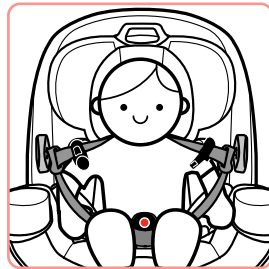

Place Child in Car Seat

On select models: You may use the In and Out Harness Holders to place the harness straps out of the way.

Your child's bottom and back should be flat against the car seat.

continued on next page

4

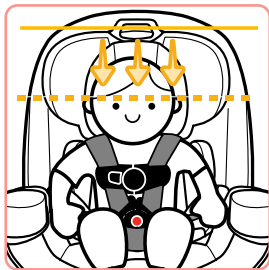

Head Position

The tops of your child's ears **MUST be below** the top of the car seat's headrest.

5

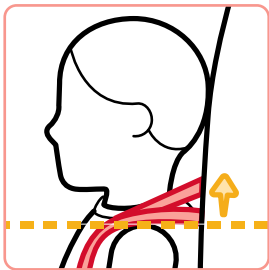

Harness Strap Position

The harness strap **MUST be at or slightly above** the shoulders; never below.

6

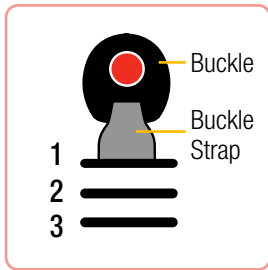

Buckle Position

- Use the slot closest to your child.
- The buckle **should not be underneath or behind** your child.

The buckle can be used in **any** buckle slot.

i

To change the harness strap height, see page 41.

To change the buckle position, see page 42.

To learn how to check harness tightness, see pages 29-30.

If you cannot achieve a snug harness fit for your child, please contact us. See the back cover for our contact information.

Forward-Facing Vehicle Install



Before installing the car seat in your vehicle, check to see if you need to adjust the buckle position for your child. **See page 20 for child fit.**

Once the car seat is installed, you will not be able to adjust the buckle position.

Review Vehicle Owner's Manual

Determine what kind of vehicle belts your car has and how to use them to lock a car seat in place **OR** where LATCH: lower anchor seating positions are located in your vehicle.

There are 2 different methods for install.

Use only one:

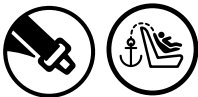

Vehicle Belt + Tether

for children up to 65 lb (29 kg)

OR



LATCH: Lower Anchor Belt + Tether

Do not install by this method for children weighing more than 40 lb (18 kg).

WARNING:

DO NOT use both the LATCH: lower anchor belt and vehicle belt at the same time to install the car seat.

When anchors are available, you **MUST ALWAYS** attach, adjust, and secure the tether (top anchorage) strap when installing the car seat in the Forward-Facing Mode with internal harness.

continued on next page

1

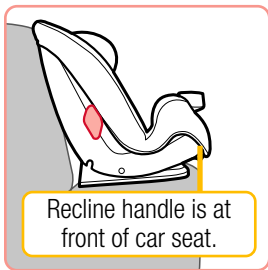

Put Car Seat into Position 1 & Place Car Seat **Forward-Facing** in Back Seat

The vehicle seat back **MUST** be upright.

i

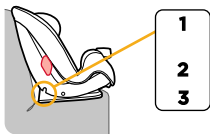

Only use semi-reclined **Position 2** if **necessary** to install the car seat flush against the vehicle seat back.

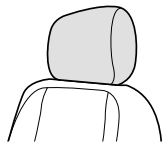

If your vehicle has a headrest that interferes with a flush car seat fit, check your vehicle owner's manual to see if it can be removed, adjusted, or if there are other possible seating locations for you to install.

2

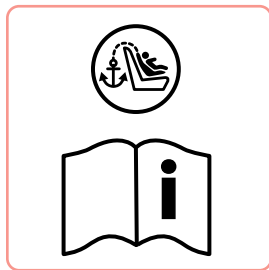

Locate Vehicle Top Tether Anchors

Review your vehicle owner's manual for top tether anchor locations and how to route the tether strap when there are vehicle headrests.

3

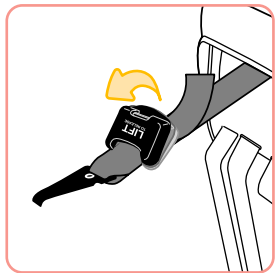

Lift Tether Adjuster
to Loosen
Tether Strap

4

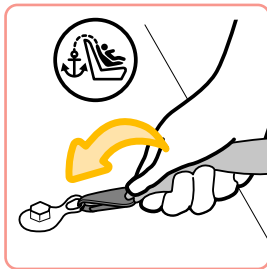

Loosely Attach
Tether Hook to
Vehicle's Top
Tether Anchor

5

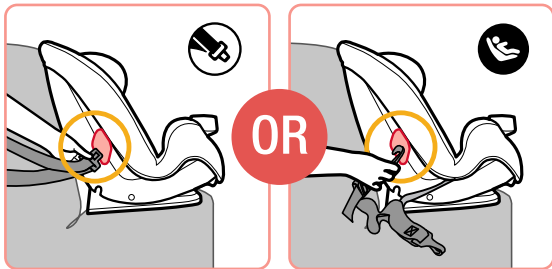

Locate **Forward-Facing Belt Path** &
Route Vehicle Belt or Lower Anchor Belt Through It

For the LATCH belt: You may need to fully lengthen the belt before routing it into the belt path. Squeeze the adjuster button and pull the belt out as shown.



continued on next page

6

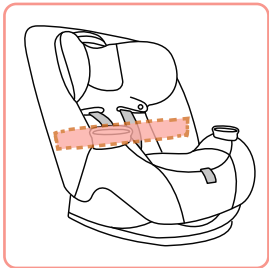

Vehicle Belt or Lower Anchor Belt Goes:

- under the car seat pad; **AND**
- across the car seat; **AND**
- out the other **Forward-Facing Belt Path** opening.

DO NOT twist the belt.

i



Adjuster

Finished Lower Anchor Belt Routing

The lower anchor belt adjuster can be on either side of the car seat.

7

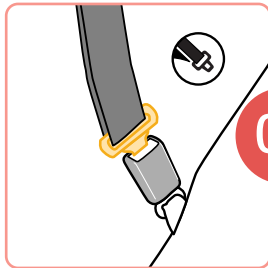

OR

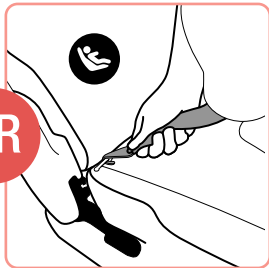

Buckle Vehicle Belt

If your car has a **switchable retractor**, use it to lock the vehicle belt.

Review page 57 of this manual or your vehicle owner's manual.

Attach Lower Anchor Belt Hooks to Vehicle's Lower Anchors

8

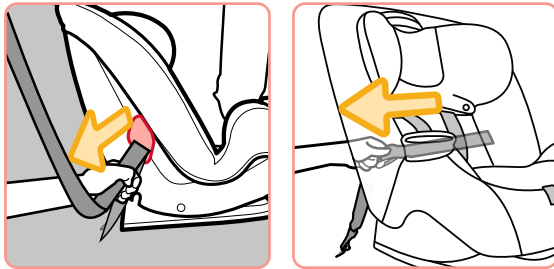

Tighten Belt

Place your hand in the car seat and firmly push the car seat down and back towards the vehicle seat. Pull the belt towards you and parallel (in line) with the belt path as shown.

For the LATCH belt or Lap Only Vehicle Belt: it may be easier to tighten if you route the free end of the belt back into the **Forward-Facing Belt Path**, reach into the **Forward-Facing Belt Path**, and pull the free end of the belt towards you.

9

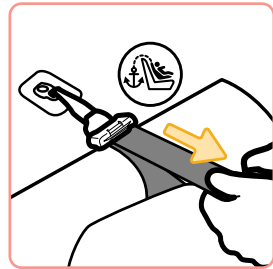

Tighten Tether

Push firmly on the back of the car seat and pull the free end of the tether strap to remove all of the slack.

10

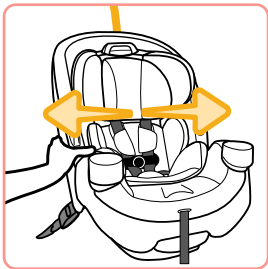

Check Belt Tightness

Hold the **Forward-Facing Belt Path** with your non-dominant hand. Push and pull from side to side.

The car seat should not move more than **1 in.** (2.5 cm).

i

If the car seat moves more than **1 in.** (2.5 cm), you can try:

- Pulling the belt tighter; **OR**
- Reinstalling the car seat; **OR**
- Changing to a different seating location; **OR**
- Switching to a different install method (LATCH or vehicle belt).

FINISHED!

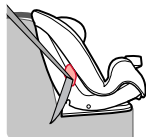

Lap/Shoulder Belt + Tether
for children up to 65 lb (29 kg)

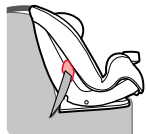

Lap Belt + Tether
for children up to 65 lb (29 kg)

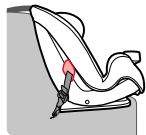

LATCH: Lower Anchor Belt + Tether



Do not install by this method
for children weighing more
than 40 lb (18 kg).

Vehicle Belt Install: Is the vehicle belt locked? See step 7.

LATCH: Lower Anchor Belt Install: Are the hooks securely attached to the vehicle's lower anchors? See step 7.

Is the belt tightened enough so the car seat does not move more than 1 in (2.5 cm) from side to side? Check the tightness of the install often to make sure it has not loosened. See steps 8 and 10.

Has the tether been installed and tightened? See steps 4 and 9.

1

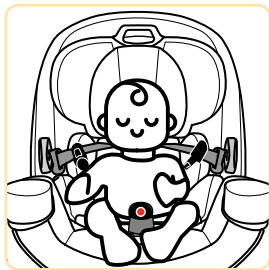

Place Child in Car Seat

Your child's bottom and back should be flat against the car seat.

2

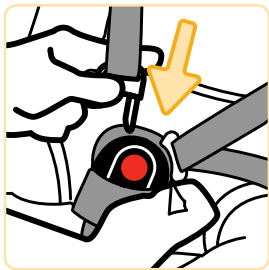

Buckle Harness

Pull the harness straps up to make sure buckle is locked.

3

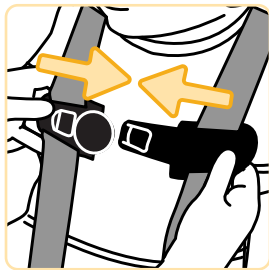

Fasten Chest Clip

Insert right half of the chest clip into the left half and snap together.

4

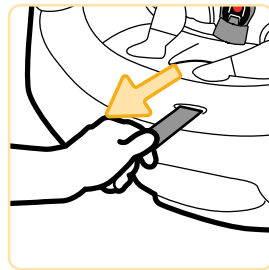

Tighten Harness

Pull the harness adjustment strap straight out to snugly tighten the harness.

5

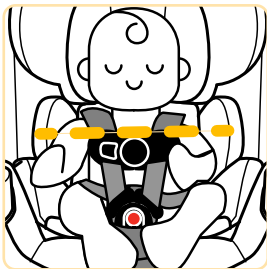

Position Chest Clip

Slide the chest clip up the harness straps and position it at mid-chest (even with armpits) and away from your child's neck.

6

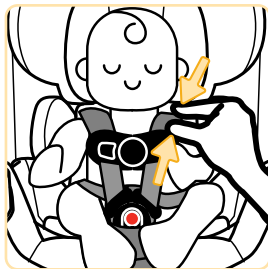

Check Harness Tightness

Unfasten the harness covers.

Try to pinch the harness at the shoulders vertically between index finger and thumb as shown.

If your fingers slip off, the harness is tight enough.

If you can pinch the harness strap, tighten more.

Fasten the harness covers.

i

A snug strap should not allow any slack.

It lies in a relatively straight line without sagging.

It does not press on the child's flesh or push the child's body into an unnatural position.

continued on next page

FINISHED!



Your child is now secured in the car seat.

Check your child's fit often and make any needed adjustments to the car seat as they grow.

To Remove Child from Car Seat:

1. Loosen Harness Strap
2. Unbuckle Harness
3. Release Chest Clip
4. Remove Child

Troubleshooting

1. If the buckle or harness release lever sticks: DO NOT lubricate. Check for dropped food, sticky spilled drinks, dirt, leaves, etc.

Clean with warm water and/or remove the object with tweezers. If you cannot get the harness to adjust and remain tight with the buckle securely locked, **do not** use this car seat.

2. If your harness twists:

Straighten the harness each time you put your child in the car seat. Lock the buckle and tighten the harness so it will be ready for next use.

WARNING:

Failure to fasten and tighten the harness system correctly may allow the child to be ejected from the child restraint in a crash or sudden stop causing serious injury or death. Serious injury can include paralysis and/or permanent brain damage.

DO NOT mistake comfort for safety. The harness system must be snugly adjusted.



DO NOT put snowsuits or bulky garments on your child when placing them in the child restraint.

Bulky clothing can prevent the harness straps from being tightened properly.

Booster Seat Section



40-100 lb (18.1-45.4 kg) and 43-52 in. (110.1-132.1 cm)

In this car seat, your child can remain in a **Booster Seat** until they outgrow any one of the following:

- **Weight Limit:** 100 lb (45.4 kg); **OR**
- **Height Limit:** 52 in. (132.1 cm); **OR**
- **Booster Seat Child Fit** requirements, see page 40.

You **MUST** store the harness system and remove the accessories, except the cup holder(s), when using the **Booster Seat Mode**.

To remove accessories, see pages 3-4.

Storing Harness System: Page 34

Booster Seat Use in Vehicle: Page 37

Booster Seat Child Fit: Page 40

⚠ WARNING:

DO NOT use the harness system when using as a booster seat.

DO NOT use LATCH when using as a booster seat. Secure the lower anchor belt and the tether strap to their storage attachments.

Warning! Use only the vehicle's lap and shoulder belt system when restraining the child in this booster seat.



DO NOT use only the lap belt when using this seat as a booster seat. The shoulder belt **MUST** always be adjusted snugly across the child's chest.

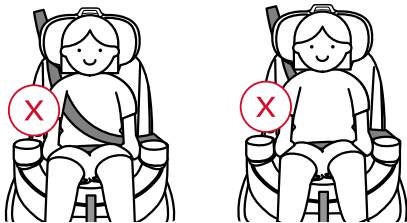

NEVER place shoulder belt under the child's arms or behind their back.

DO NOT use this booster seat if the tops of your child's ears are above the top of the booster seat's headrest.

Storing Harness System

1

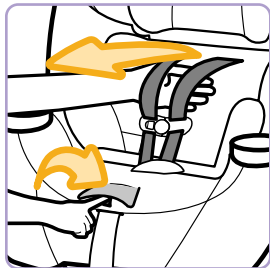

**Fully Loosen
Harness Straps**

2

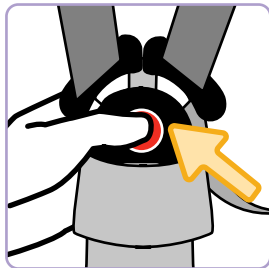

Undo Buckle

3

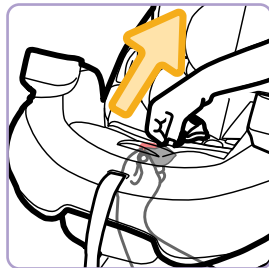

Recline Car Seat

Reach under the car seat.
Rotate the buckle's metal
retainer and push it up
through the car seat.

4

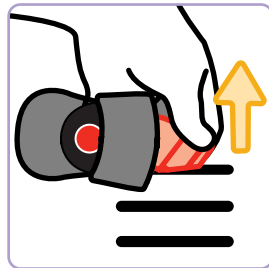

**Pull Buckle & Buckle
Cover Out of Car Seat**

Store the buckle and buckle
cover in a safe place for
future use.

continued on next page

5

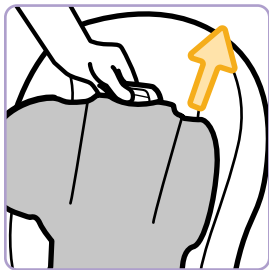

**Adjust Headrest to
Highest Position**

6

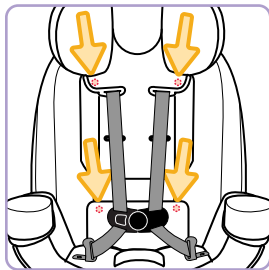

**Undo Fasteners on
Headrest Pad &
Seat Pad**

7

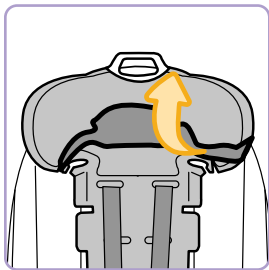

**Pull Headrest Pad
Off Bottom of
Headrest**

8

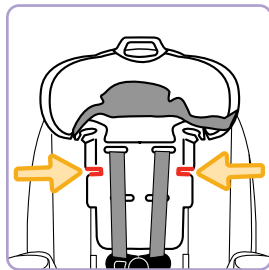

**Thread Harness
Straps into
Slots on Sides
of Headrest**

9

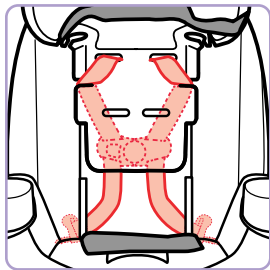

**Place Chest Clip,
Harness Straps,
& Buckle Tongues
Behind Headrest**

10

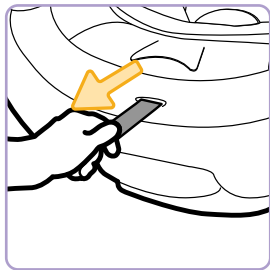

Tighten Harness
Remove any slack from the
harness system.

11

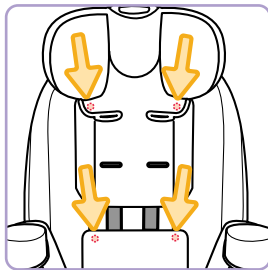

**Wrap Headrest Pad
Around Bottom
of Headrest**

On select models: Attach the
fasteners on the headrest pad
and the seat pad.

FINISHED!

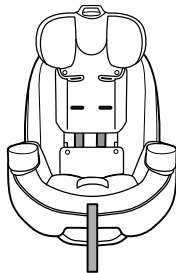

The car seat has
been converted to the
Booster Seat Mode.

See next page for
**Booster Seat Use in
Vehicle.**

1

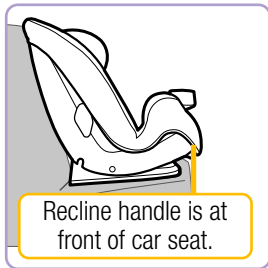

Put Booster Seat into Position 1

The vehicle seat back **MUST** be upright.

i



- 1
- 2
- 3

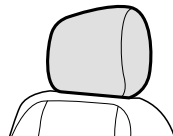

Only use semi-reclined **Position 2** if **necessary** to install the booster seat flush against the vehicle seat back.

If your vehicle has a headrest that interferes with a flush car seat fit, check your vehicle owner's manual to see if it can be removed, adjusted, or if there are other possible seating locations for you to install.

2

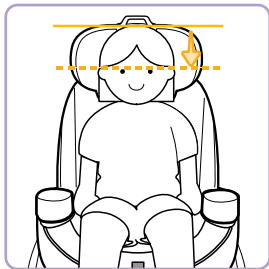

Have Child Sit in Booster Seat

The tops of your child's ears should never be above the top of the booster seat's headrest.

3

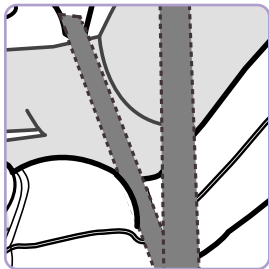

Position Lap Belt on Child

Route the lap belt portion of the vehicle belt through the **Booster Seat Belt Path** as shown. The lap belt should lay snugly across your child's hips; not on their stomach.

4

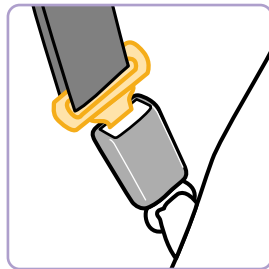

Buckle Vehicle Belt

Pull the lap belt up to tighten.

continued on next page

5

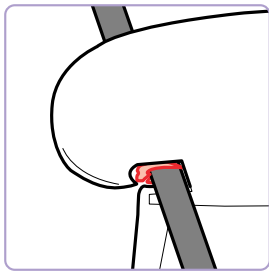

Position Shoulder Belt on Child

Thread the shoulder belt through the belt-positioning guide in the headrest.

Pull the shoulder belt up to tighten so that it lies snugly across the center of your child's shoulder and across their chest.

For models with In and Out Harness Holders: The shoulder belt should lay under the In and Out Harness Holder.

For models without In and Out Harness Holders: The shoulder belt will fall naturally into place.

FINISHED!

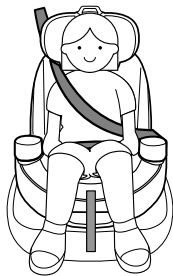

Check periodically to make sure your child has not moved out of position and loosened the shoulder belt.



Keep the booster seat securely belted even when unoccupied.

Booster Seat Child Fit

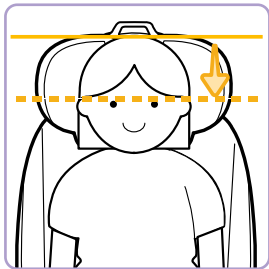

Head Position

The tops of your child's ears should **never be above** the top of the booster seat's headrest.

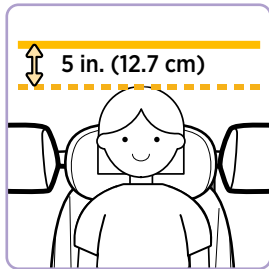

Car Position

DO NOT use the booster seat if your child's head is less than 5 in. (12.7 cm) below the roof of the car. Consult your vehicle manual for proper seatbelt usage.



Shoulder Belt Position

The shoulder belt should lay snugly across the center of your child's shoulder and across their chest.

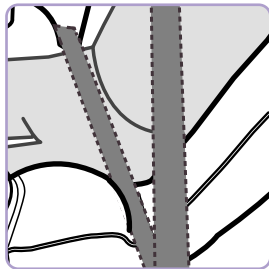

Lap Belt Position

The lap belt should lay snugly across your child's hips; **not on their stomach.**

1

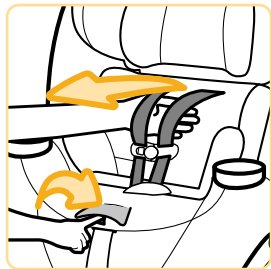

Fully Loosen Harness Straps

Push down on the harness release lever (through the opening in the pad) while pulling out on the harness straps as shown.

2

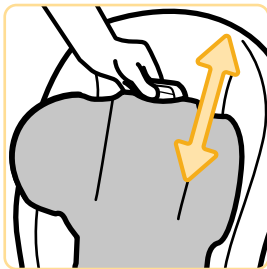

Adjust Headrest/Harness Height

1. Squeeze the adjustment handle lever up.
2. Move the headrest up or down to the proper height for your child.
3. Release the handle to lock in place.
4. Make sure it is locked securely.

i

For Rear-Facing Child Fit, see page 9.

For Forward-Facing Child Fit, see page 20.

To learn how to check harness tightness, see pages 29-30.

If you cannot achieve a snug harness fit for your child, see pages 44-47.

Check the harness straps often for any wear or damage.

Changing Buckle Position

⚠️ WARNING:

Failure to place buckle's metal retainer completely through pad and child restraint can result in serious injury or death. Serious injury can include paralysis and/or permanent brain injury.

1

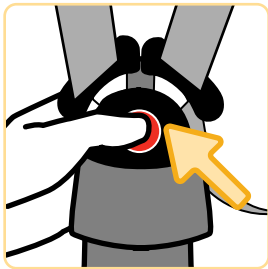

Unbuckle Harness

Press in towards the top of the red button.

2

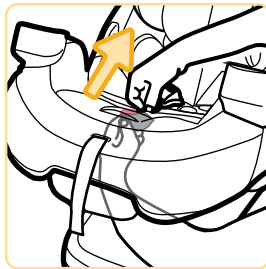

Recline Car Seat

Reach under the car seat. Rotate the buckle's metal retainer and push it up through the car seat.

3

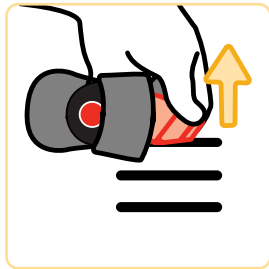

From Top of Car Seat, Pull Buckle & Buckle Cover Out of Car Seat & Pad

continued on next page

4

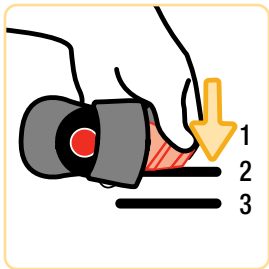

Insert Buckle's Metal Retainer into Buckle Slot Closest to Child

Tuck the ends of the buckle cover into the same pad slot as the buckle.

5

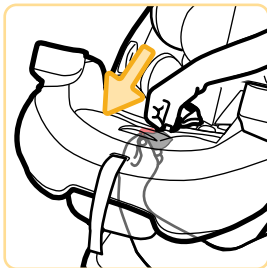

Reach Under Car Seat Between Base & Car Seat

Pull the buckle's metal retainer completely through the seat pad and car seat.

6

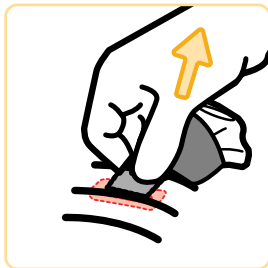

Check Buckle

Pull up on the buckle to make sure it is secured.

The buckle **MUST NOT** pull out.

i

For Rear-Facing Child Fit, see page 9.

For Forward-Facing Child Fit, see page 20.

To learn how to check harness tightness, see pages 29-30.

If you cannot achieve a snug harness fit for your child, see pages 44-47.

Harness System Adjustments for Smaller Infants

i

If you cannot achieve a snug harness fit for your child, you may need to adjust the buckle strap and/or harness strap length and location as shown in this section.

⚠ WARNING:

The harness system **MUST BE** installed correctly. **DO NOT** use a child restraint with damaged harness straps.

Adjusting Buckle

1

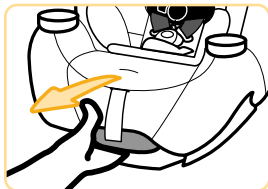

With Buckle in 1st Slot, Fully Recline Car Seat

If you need to move the buckle to the 1st slot, see pages 42-43.

2

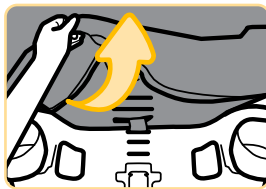

Pull Front of Car Seat Pad Up

3

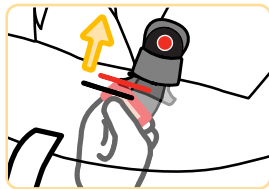

Reach Under Car Seat

Pull the buckle's metal retainer down and then push it up into the middle slot as shown.

continued on next page

3

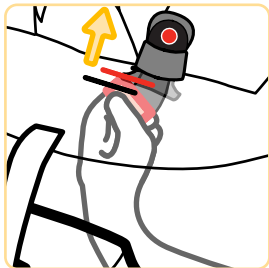

Reach Under Car Seat

Pull the buckle's metal retainer down and then push it up into the middle slot as shown.

4

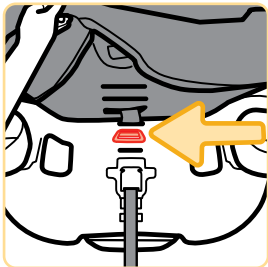

From Top of Car Seat, Lay Metal Retainer Flat Against Car Seat

5

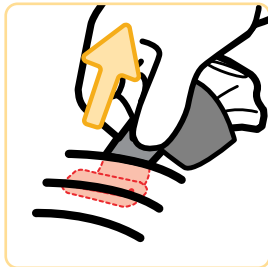

Tuck Car Seat Pad Around Front of Car Seat & Check Buckle

Pull the buckle up to make sure it is secured.

The buckle **MUST NOT** pull out.

i

When using the lower shoulder harness slots for smaller children, you **MUST** use the head and body pillow and the headrest **MUST** be in the lowest position.

Adjusting Harness Straps

1

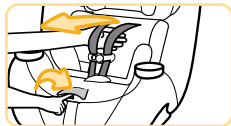

**Adjust Headrest to
Lowest Position &
Fully Loosen
Harness Straps**

2

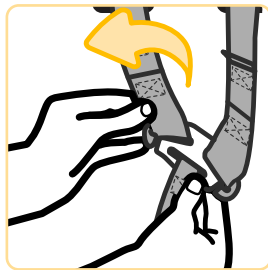

**From Back of
Car Seat,
Remove Harness
Strap Loops From
Splitter Plate**

3

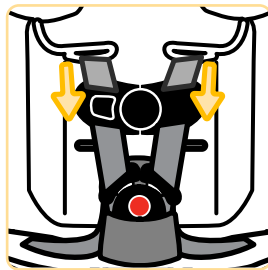

**Pull Harness
Straps Out of
Upper Shoulder
Harness Slots**

continued on next page

4

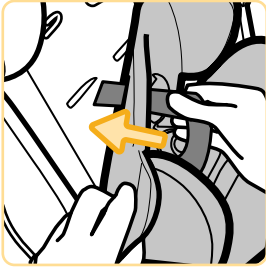

Pull Body Pillow Forward Away from Car Seat

Thread the harness straps through the slots in the pillow, the lower shoulder harness slots in the seat pad, and the car seat.

5

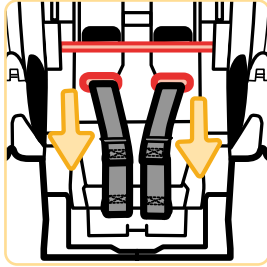

From Back of Car Seat, Pull Harness Straps Through Car Seat

The harness straps **MUST** be in the shoulder harness slots **below** the metal bar.

6

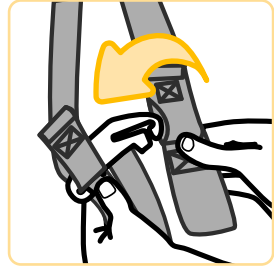

Attach 2nd Harness Strap Loops to Splitter Plate

i

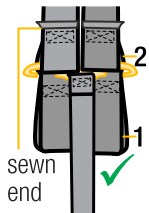

The sewn ends of the harness strap loops **MUST** face towards you.

DO NOT twist the harness strap or the harness adjustment strap.

Make sure the same harness strap loops are fitted completely on both sides of the splitter plate.

To return the harness straps to upper shoulder harness slots, follow the steps below to rethread them.

1. Remove Harness Strap Loops From Splitter Plate & Pull Harness Straps Out of Lower Shoulder Harness Slots in Body Pillow & Car Seat



2. Thread Harness Straps into Upper Shoulder Harness Slots in Seat Pad & Car Seat

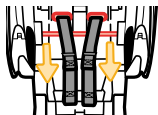

3. From Back of Car Seat, Thread Harness Straps **Over** Metal Bar

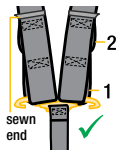

4. Attach 1st Harness Strap Loops to Splitter Plate



If harness straps have been removed from chest clip & buckle, rethread them:

The harness strap ends go through the **back** of the buckle tongues & through the chest clip **front to back**.

Reclining Car Seat

This car seat has 3 positions.

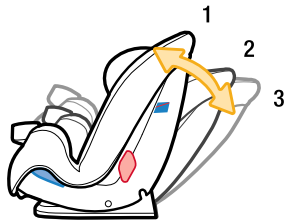

Rear-Facing Mode - 3 Reclined or 2 Semi-reclined

For children **who cannot** sit up unassisted, the **Rear-Facing Level Line** on the car seat **MUST** be parallel with the ground using either **Position 3 or 2**.

For children **who can** sit up unassisted, you may make the car seat more upright in **Position 2**.

Forward-Facing Mode - 1 Upright or 2 Semi-reclined*

Booster Seat Mode - 1 Upright or 2 Semi-reclined*

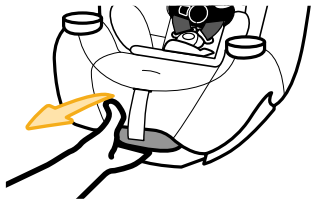

To Recline: Pull the recline handle out and push the top of the car seat back.

For More Upright: Pull the recline handle out and pull the top of the car seat forward.



*When used in **Forward-Facing Mode** or **Booster Seat Mode**, semi-reclined **Position 2** is **ONLY** to be used **if necessary** to install the car seat flush against the vehicle seat back.

The vehicle seat back **MUST** be upright.

Removing Seat Pad Set

i

You do not need to remove the harness system to remove the pad from the car seat.

DO NOT fully pull the harness strap out of the car seat. Leave it threaded in the hip harness slots. If removed, you will not be able to rethread it.

To remove accessories, see pages 3-4.

1

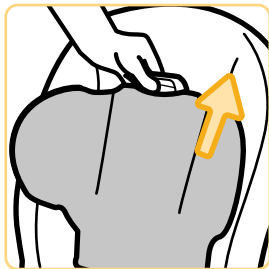

Adjust Headrest to Highest Position

2

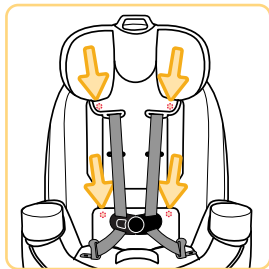

**On Select Models:
Undo Fasteners on
Headrest Pad &
Seat Pad**

3

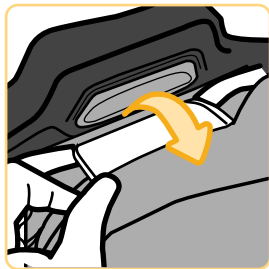

**Locate Pad Fabric
Tab Slot in Headrest**

Pull the fabric tab out of the slot in the headrest as shown.

continued on next page

4

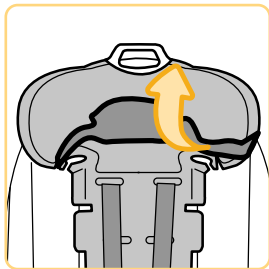

**Gently Pull Headrest
Pad Off Bottom of
Headrest**

5

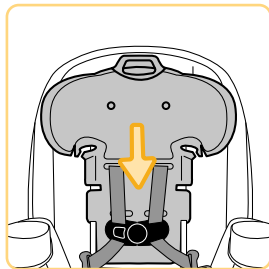

**Lower Headrest to
Middle of Car Seat**

6

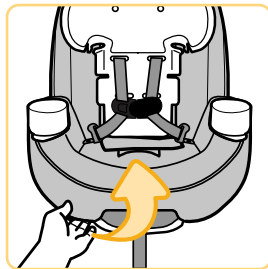

**Pull Seat Pad Off
Sides & Front of
Car Seat**

7

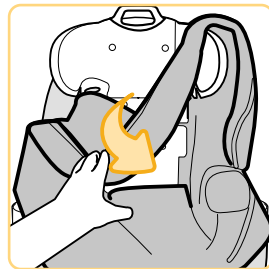

**Pull Seat Pad Around
Headrest & Off of
Car Seat**

Cleaning Parts of Car Seat & Installing Seat Pad Set

Cleaning Pad & Accessories

Machine wash separately with cold water on a gentle cycle. Make sure the harness covers are closed so the fastening strips are not exposed. **DO NOT** use bleach. Tumble dry separately for 10-12 minutes on low heat. Remove immediately.

Cleaning Harness Strap

Check the harness straps often for any wear or damage. Spot clean using warm sudsy water and damp cloth. Spilled food and liquids on the car seat may result in mold or bacterial growth over time. These spills could also attract insects or rodents.

Cleaning Buckle & Car Seat

Spot clean using warm sudsy water and damp cloth. **DO NOT** submerge into water.

Installing Seat Pad Set

1. Lower Headrest to Middle of Car Seat
2. Pull Seat Pad Around Headrest and onto Car Seat
3. Pull Headrest Pad onto Headrest
4. Push Headrest Pad Fabric Tab into Slot in Headrest
5. On Select Models: Attach All Pad Fasteners

WARNING:

DO NOT fully pull the harness strap out of the car seat. Leave it threaded in the hip harness slots. If removed, you will not be able to rethread it. **DO NOT** use the child restraint without the seat pad or with damaged harness straps.

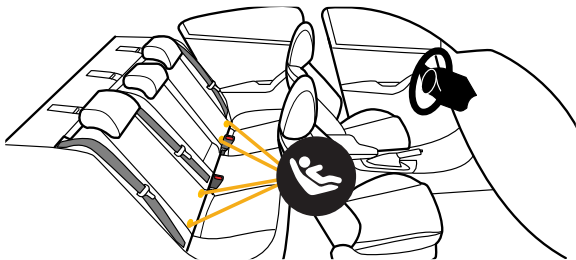

Your vehicle's features may be considerably different than those pictured here.

The lower anchors of **LATCH** (**L**ower **A**nchors and **T**ethers for **C**hildren) is a universal system for installing car seats without using vehicle seat belts. The LATCH: lower anchor belt can **ONLY** be used in vehicles that have the lower anchor bars installed in designated seating positions. Most vehicles manufactured after September 2002 are equipped with LATCH: lower anchor bars. Check your vehicle owner's manual to see which seating positions may be equipped with LATCH: lower anchor bars.



Lower Anchor Belt Storage Location

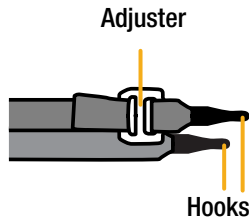

Lower Anchor Belt Parts

To Remove Lower Anchor Belt from Storage Location on Car Seat

Squeeze the spring lever on the hooks and remove the hooks from the attachments in the storage location.



To Remove Lower Anchor Belt from Vehicle's Lower Anchor Bars

1. Remove the tension from the belt by pushing down on the side of the car seat with the adjuster.
2. Then press the adjuster's button to loosen the belt.
3. Squeeze the spring lever on the hooks, push the hooks back into the vehicle seat, and rotate the hooks to the side.
4. Pull the hooks out of the vehicle seat.

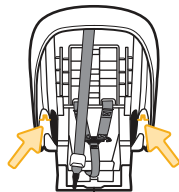

To Store Lower Anchor Belt

The lower anchor belt **MUST** be properly stored in its storage location when:

- using the vehicle belts to install the car seat; **OR**
- using the **Booster Seat Mode**; **OR**
- the car seat is not installed in a vehicle.

Secure the hooks to the attachments in the storage location as shown. Gently tighten the belt to remove slack.

⚠ WARNING:

DO NOT use both the lower anchor belt and vehicle belt at the same time.

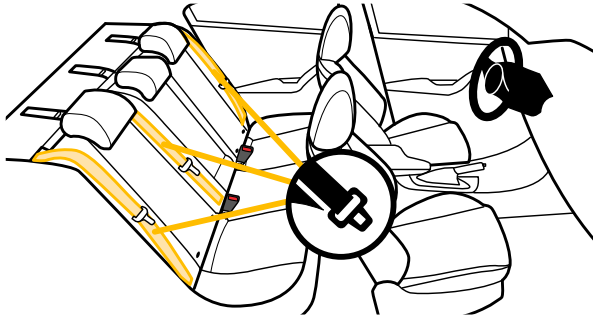

Your vehicle's features may be considerably different than those pictured here.

If LATCH: lower anchors are not an option or if your child weighs more than **40 lb** (18 kg), you must use the vehicle seat belt system to install the car seat.

Not all vehicle belts and seating positions will work with car seats. Please go through the steps following steps to understand how to lock a car seat in **Rear-Facing Mode or **Forward-Facing Mode** with a vehicle belt.**

1

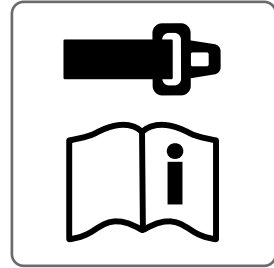

You **MUST** Review Your Vehicle Owner's Manual

Your vehicle owner's manual will let you know which vehicle belts and seating positions car seats can be installed in.

2



Check How This Car Seat Will Be Locked Into Place

The vehicle belt **MUST NOT** loosen after tightening.

This means there needs to be a way to lock the vehicle belt.

The ways this can be done are:

- By using the seat belt's retractor (see step 3); **OR**
- By using the seat belt's latch plate (see step 4).

3

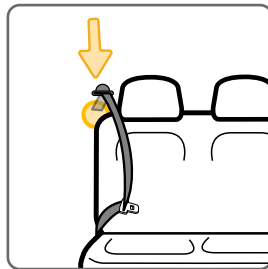

Check Retractor

Retractors pull seat belts into stored positions and lock the belt to hold passengers in place.

See the next page for some common types of vehicle belt retractors that will work with this car seat.

continued on next page



Switchable Retractor

(most vehicles have this type)

This retractor can be switched to a locking mode.

You **must have the retractor in the locking mode** to use the seat belt with this car seat.

Switching to locking mode: Slowly pull the shoulder belt all the way out, then let it go back in **1-2 in.** (2.5-5 cm).

As it goes back in, you will most likely hear a ratcheting sound.

Gently pull the belt to see if it has locked. You will not be able to pull any more belt out if the lock has engaged.

Automatic Locking Retractor

This retractor always locks.

It will automatically lock after slowly pulling the seat belt out at least halfway and letting the belt go back into the retractor **1-2 in.** (2.5-5 cm).

Emergency Locking Retractor

See Step 4

“Check Latch Plates”

If the retractor does not lock, it is most likely an Emergency Locking Retractor. These retractors only lock during a sudden stop or collision.

You will need to determine if your seat belt's latch plate can lock the belt. See step 4, “Check the Latch Plates”.

4

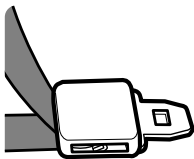

Locking
Latch Plate

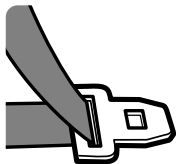

Emergency
Locking
Retractor with
a Sliding Latch
Plate

Check Latch Plates

Latch plates are the part of the seat belt that goes into the buckle.

To see if the latch plate locks:

1. Buckle Vehicle Belt
2. Firmly Tug Lap Portion of Seat Belt While Pulling It Up

If the vehicle belt does not slide through the latch plate, it's locked.

If the latch plate slides up and down the vehicle belt, it is a **sliding latch plate**.

Sliding latch plates easily slip between the lap and shoulder portions of the belt.

i

If you have an Emergency Locking Retractor with a Sliding Latch Plate, you must use a locking clip.

Please contact us for one, see the back cover of the manual.

Never Use the Following With This Car Seat:

- Emergency Locking Retractor Lap Only Belt
- Inflatable Seat Belts

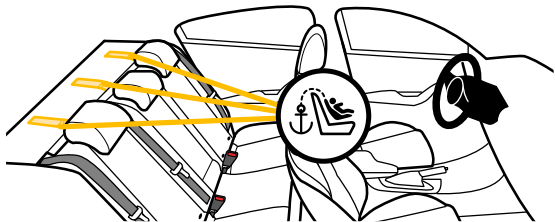

Your vehicle's features may be considerably different than those pictured here.

When anchors are available, you **must always attach, adjust, and secure the tether (top anchorage) strap** when installing the car seat in the **Forward-Facing Mode** with internal harness. Tethers improve the installation and stability of car seats and reduce the risk of injury. Attach the tether hook to the tether anchor designated by your vehicle manufacturer for that seating position. Check your vehicle owner's manual for more information. If the seating position does not have a tether anchor, use a different seating position or see your dealer or a qualified mechanic and have one installed.

⚠ WARNING:

Using this child restraint without the tether strap anchored as required by the manufacturer would be a misuse of the child restraint and, in a sudden stop or crash, could result in serious injury or death.

Serious injury can include paralysis and/or permanent brain injury.

DO NOT fasten multiple tether hooks on the same tether anchor in the vehicle.

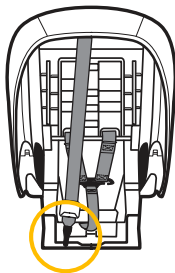

Storing Top Tether Strap

The tether strap **MUST** be properly stored in its storage location when:

- installing in **Rear-Facing Mode**; **OR**
- using the **Booster Seat Mode**; **OR**
- the car seat is not installed in a vehicle.

Attach the tether hook to its storage location as shown. Gently tighten to remove slack.

Child Restraint Use

WARNING:

NEVER take your child out of the child restraint while the vehicle is moving.

NEVER leave your child unattended. Placing your child in a hot child restraint may result in burns.

DO NOT use a child restraint with damaged or missing parts.

DO NOT use a child restraint with cut, frayed, or damaged harnesses.

DO NOT substitute parts or try to modify the child restraint in any way. **DO NOT** lubricate buckles and fasteners.

DO NOT use any child restraint accessory except those approved by Dorel Juvenile Group.

NEVER allow any child to play with this child restraint; it is not a toy.

DO NOT remove or cover up any of the warning labels or other labels on the child restraint.

This child restraint has been certified for use in passenger vehicles. **DO NOT** use in a boat, on a motorcycle or in a cargo van or bus where there are no seat belts or tether anchors.

Read all instructions for additional warnings.

WARNING:



NEVER place a child rear-facing in a seating position with an active frontal air bag.

Check the vehicle owner's manual for more information about air bag/child restraint use.



Use the child restraint only on vehicle seats that face forward.



DO NOT use on seats that face the sides or rear of the vehicle.

For vehicles without a back seat, refer to your vehicle owner's manual.



Children are safer when properly restrained in rear seating positions than in the front seating positions.

According to accident statistics, children in rear seating positions are statistically safer, whether you have air bags, advanced air bags, or no air bags at all.

If you are not sure where to place the car seat in your vehicle:

- Consult your vehicle owner's manual; **OR**
- Contact Dorel Juvenile Group Consumer Care Department; **OR**
- Visit your local Child Passenger Inspection Station. Go to <http://www.safercar.gov/cpsApp/cps/index.htm> to find your closest station.

Installation in Vehicle

To avoid your child being seriously burned, take the following precautions:

- Park in the shade or where the sun does not directly hit the car seat.
- Cover the car seat with a sheet or blanket when not in use.
- Check for hot seat and buckles before placing child in car seat.

To help protect your vehicle seat's upholstery from damage: you may use an accessory approved by Dorel Juvenile Group or a single layer towel underneath and behind car seat.

WARNING:

Check the vehicle belt or lower anchor belt before each use. Use only if the belt can be tightened properly and locked securely in place.

Even when unoccupied, this child restraint **MUST** be firmly secured to the vehicle with the lower anchor belt or with the vehicle seat belt.

Even when unoccupied, this booster seat **MUST** be firmly secured to the vehicle with the vehicle seat belt.

In a crash or sudden stop, an unsecured child restraint or booster seat could injure occupants.

DO NOT risk your child's safety.

To keep your child as safe as possible, Dorel Juvenile Group strongly recommends replacing the car seat even after a minor crash; even if it was not occupied at the time.

Replacement After a Minor Crash

The National Highway Traffic Safety Administration states that for a crash to be considered minor **ALL of the following MUST be true:**

- Vehicle able to drive away from the crash site; **AND**
- Vehicle door nearest the car seat was not damaged; **AND**
- No passengers were injured; **AND**
- Airbags did not deploy; **AND**
- There is no visible damage to the car seat.

If the crash your car seat was involved in meets **ALL** the criteria, you may not need to replace the car seat.

If one or more of these criteria are not true or if you are uncertain of any of your answers, replace the car seat immediately.

Replacement After a Moderate to Severe Crash

You **MUST** replace this car seat if it has been in a moderate to severe car crash.

This car seat is intended to protect a child in a single crash. During a crash, the car seat and all of its parts absorb crash energy which can deform or weaken it. Damage is not always visible. A damaged car seat **MUST** be replaced immediately.



Expiration

On the side of the car seat there is a date of manufacture label as shown.

DO NOT use this car seat more than 10 years after the date of manufacture.

Registration and Safety Notices

Please complete the postage-paid registration card that came with your child restraint, and send it to us.

Child restraints could be recalled for safety reasons.

You must register this restraint to be reached in a recall.

Send your name, address, e-mail address if available and the restraint's model number and manufacturing date to:

Dorel Juvenile Group

2525 State Street
Columbus, IN 47201

or call 1-800-544-1108 or register online at
www.djgusa.com/registration/carseat/us.

For recall information, call the U.S. Government's Vehicle Safety Hotline at 1-888-327-4236 (TTY: 1-800-424-9153), or go to www.NHTSA.gov.

0515079 *Tear Off and Mail This Part or Register Online* 4348-0081D

Consumer: Just fill in your name, address and email. Please print (use dark ink).

Your Name

Your Street Address

City State Zip Code

Email Address (optional)

Model Number	Model Name	Manufacture Date
AB123CDE	Brand Car Seat	05/16/2015

L#11 B265035

Example of model number, manufacture date, and line code.



If you don't have the card or if your address changes, you will find the model number, manufacture date, and line code on the label located on the side of the car seat.

This restraint is certified for aircraft use when used with the internal harness.



Rear-Facing Aircraft Installation

Follow the vehicle belt install steps on pages 11-17.



Forward-Facing Aircraft Installation

Follow the vehicle belt install steps on pages 22-28, skipping the tether strap steps.



Booster Seat

This restraint is not certified for aircraft use when used as a booster seat because aircraft seats do not have shoulder belts.

Install the car seat in a window seat to avoid blocking the aisle. If the aircraft lap belt is too short, ask the flight attendant for a belt extender.

Use only on forward-facing aircraft seats. Contact the airline for their specific policies.

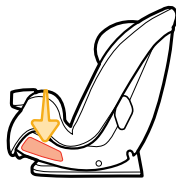

Some airlines may ask to see a label stating that this car seat is certified for aircraft use.

There is an airplane certification label located on the side of this car seat as shown.

WARNING:

You **MUST** store the lower anchor belt and tether strap when installing with aircraft belts.

Warranty

Dorel Juvenile Group, Inc. (DJG) warrants this product to the original retail purchaser as follows: This product is warranted against defective materials or workmanship for one year from the date of original purchase.

An original receipt is required to validate your warranty.

DJG will, at its option, provide replacement parts or replace this product. DJG reserves the right to substitute if the part or model has been discontinued.

To make a claim under this warranty, please contact our Consumer Care Department by phone: 1-800-544-1108 or text: 1-812-652-2525. Our hours of operation are from 8:00 a.m. to 6:00 p.m. EST Monday through Thursday and from 8:00 a.m. to 4:30 p.m. on Friday.

Proof of purchase is required and shipping charges are the responsibility of the consumer.

Warranty Limitations: This warranty does not include damages which arise from misuse or abuse of this product.

Limitation of Damages: The warranty and remedies as set

forth are exclusive and in lieu of all others, oral or written, expressed or implied. In no event will DJG or the dealer selling this product be liable to you for any damages, including incidental or consequential damages, arising out of the use or inability to use this product.

Limitation of warranties and other warranty terms and state law rights: Any implied warranties, including implied warranties of the merchantability and fitness for a particular purpose, shall be limited to the duration and terms of the express written warranty.

Some states do not allow limitations as to how long an implied warranty lasts or the exclusion or limitation of incidental or consequential damages, so the above limitations may not apply to you.

This warranty gives you specific legal rights, and you may have other rights, which vary from state to state. Neither DJG nor the dealer selling this product authorized any person to create for it any other warranty, obligation, or liability in connection with this product.

You can also:



Send Us a Text: 1-812-652-2525
(US and Canada Only.
Carrier Fees May Apply)



Find Us Online: www.safety1st.com
Email Us: support@djgusa.com



Give Us a Call: 1-800-544-1108
(Toll Free, US and Canada Only)



safety 1st



**SCAN
HERE**
TO LEARN
MORE



Replacement Parts List

(on select models)

- Buckle Assembly
- Chest Clip
- Seat Pad Set
- Removable Cup Holder(s)
- Lower Anchor Belt
- Top Tether
- Locking Clip
- Instructions

For parts availability and questions,
call, text, or chat.

If requested color is not available, similar
color will be substituted.

Applicable tax and shipping & handling will also
be added.