



4358-7097
8.29.16

Safety 1st[®]

Grow and Go[™] 3-in-1 Car Seat

rear-facing child restraint

5-40 lb (2.3-18 kg) and 19-40 in. (48-101.6 cm)

forward-facing child restraint

22-65 lb (10.1-29 kg) and 29-49 in. (73.6-125 cm)
and at least 1 year old

booster seat

40-100 lb (18.1-45.4 kg) and 43-52 in.
(110.1-132.1 cm) and at least
4 years old

KEEP INSTRUCTIONS FOR FUTURE USE.

Read all instructions
before using this
child restraint.



Safety 1st[®]

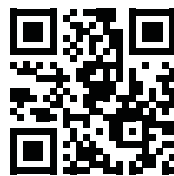

To see installation videos, scan the QR Code
or visit www.safety1st.com

©2016 Dorel Juvenile.

⚠ WARNING:

Failure to follow the warnings on the labels and in the
instruction manual can result in serious injury or death
to your child.

Choosing Rear Facing, Forward Facing, or Booster Seat

Your child's height, weight, and age determine how your child restraint should be placed in the vehicle.

Children up to 1 year of age must ride rear facing.

The American Academy of Pediatrics recommends that children should remain rear facing until they are at least 2 years old.

Please talk to your doctor about which is the best option for your child.

In this child restraint, your child can remain rear facing up to 40 lb (18 kg) and up to 40 in. (101.6 cm).

⚠ WARNING: Verify your child's weight and height (do not guess) before choosing the child restraint's placement.

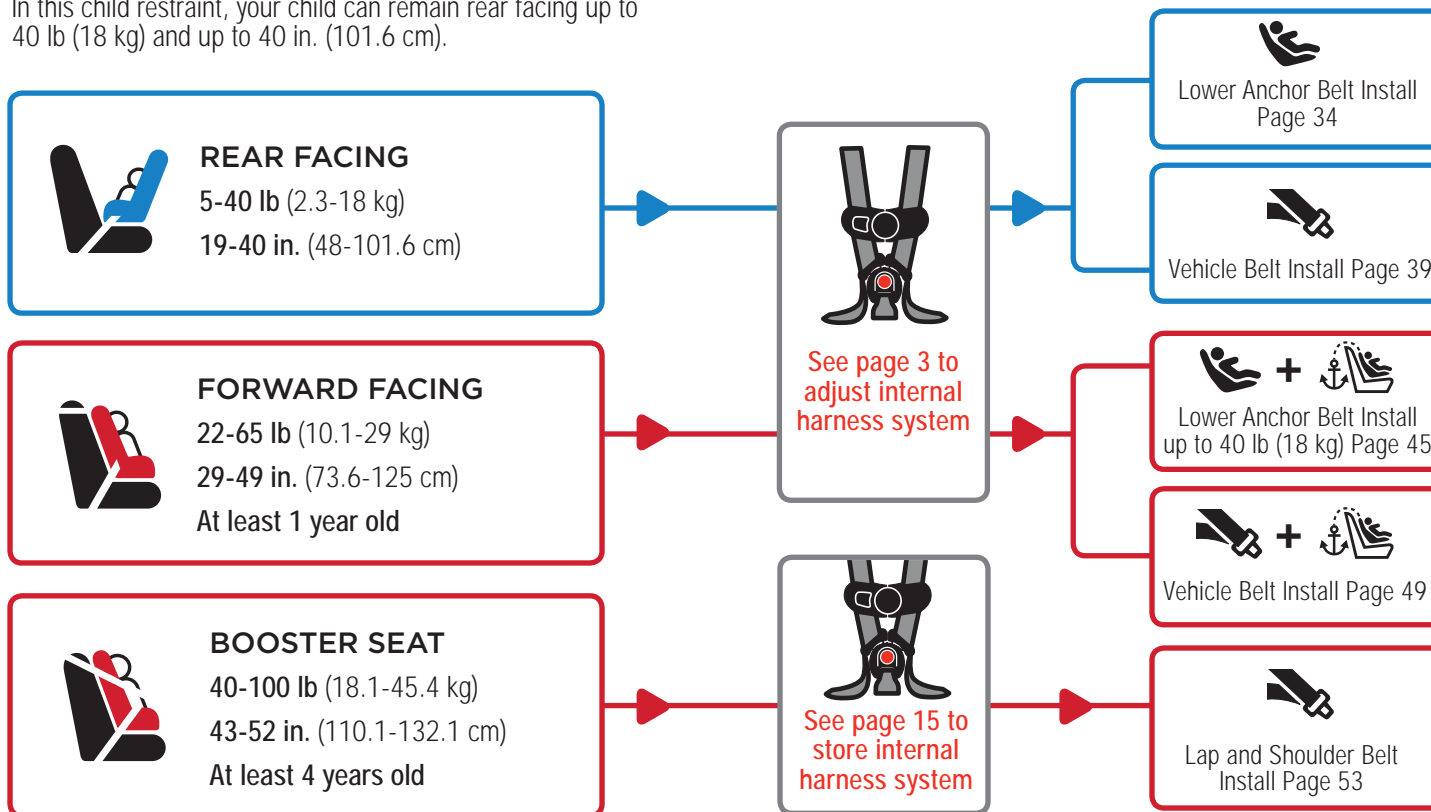













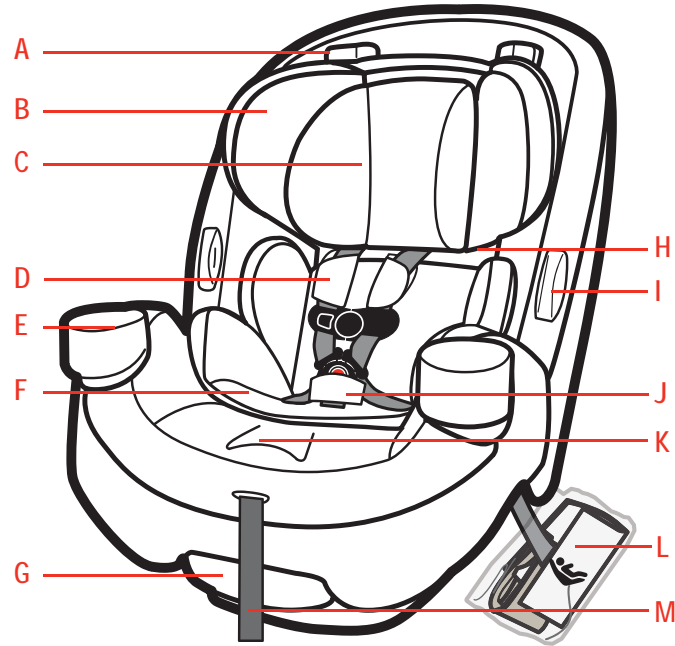

Table of Contents

 Getting Started.....	1
Parts of the Child Restraint.....	1
Prepare Child Restraint to Fit Your Child	3
How Does Your Child Fit?	5
Changing Position of Buckle	6
Adjusting Headrest/Harness Height	8
Harness System Adjustments for Smaller Infants.....	9
Securing Child in Child Restraint.....	12
 General Use	14
Reclining Child Restraint	14
Storing Harness System.....	15
Removing Seat Pad for Cleaning.....	18
Installing Harness System	21
Accessories on Select Models	24
 Safety Information.....	25
Child Restraint Use	25
Installation in Vehicle	25
Vehicle Seating Position.....	26
 Vehicle Information.....	27
Choosing Lower Anchor or Vehicle Belts	27
Knowing Your Vehicle Belts.....	29
Aircraft Information	32
 Rear Facing	33
 Lower Anchor Belt Installation.....	34
 Vehicle Belt Installation	39
 Forward Facing	43
 Tether Use.....	44
 Lower Anchor Belt Installation.....	45
 Vehicle Belt Installation	49
 Booster Seat	52
 Lap and Shoulder Belt Installation	53
 Important Information.....	55
Using a Locking Clip	55
Dorel Juvenile Group Information.....	57
Registration and Safety Notices	58
Troubleshooting.....	59
Replacement Parts Order Form.....	60
Warranty.....	62

Parts of the Child Restraint

Front View



- A. Headrest/Harness Adjustment Levers
- B. Adjustable Headrest
- C. Head Pillow (see page 24)
- D. Harness Covers (see page 24)
- E. Cup Holders
- F. Body Pillows (see page 24)
- G. Recline Handle
- H. Shoulder Belt-Positioning Guide (behind headrest pad)

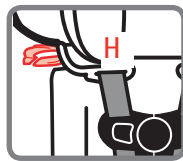

- I. Easy Out Harness Holders
- J. Buckle Cover
- K. Harness Release Lever (under flap)
- L. Lower Anchor Belt (see page 27)
- M. Harness Adjustment Strap

Side View

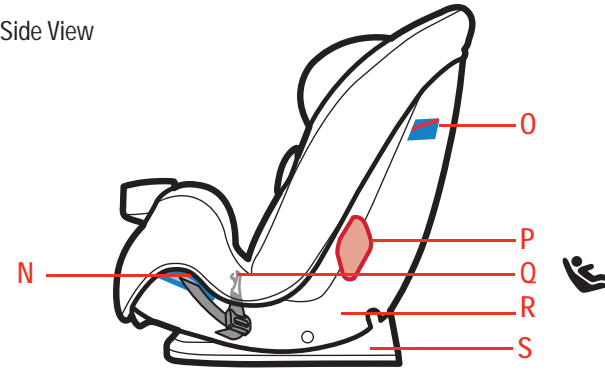

Harness System Detail

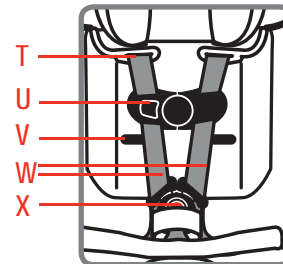

- N. Rear-Facing Belt Path
- O. Rear-Facing Level Line
- P. Forward-Facing Belt Path
- Q. Lower Anchor Belt Attachment for Storage
- R. Shell (child restraint)
- S. Base
- T. Upper Shoulder Harness Slots
- U. Chest Clip

Back View

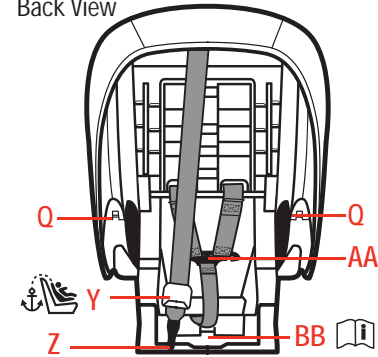

- V. Lower Shoulder Harness Slots for Smaller Infants
- W. Harness Straps
- X. Buckle
- Y. Tether (see page 44)
- Z. Tether Attachment for Storage
- AA. Splitter Plate
- BB. Instruction Manual Storage (in bottom of base)

Prepare Child Restraint to Fit Your Child

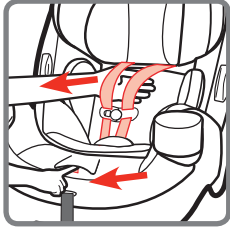

1. Fully Loosen Harness Straps

Push down on harness release lever (under flap on front of seat pad) while pulling out on harness straps as shown.



2. Unbuckle Harness

Press in towards the **top** of the red button.
Pull buckle tongues out.

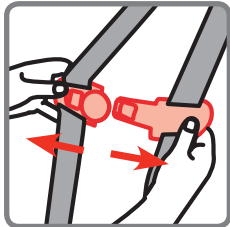

3. Release Chest Clip

Press on chest clip release button and pull apart.

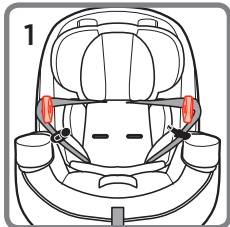

4. Place Harness Straps Out of Way

The Easy Out Harness Holders can be used two ways.

1. You can secure the harness straps around them as shown.

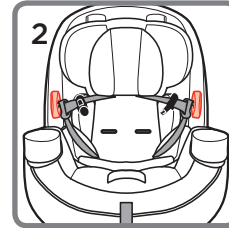
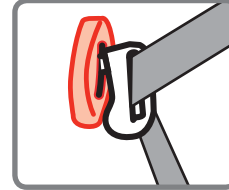
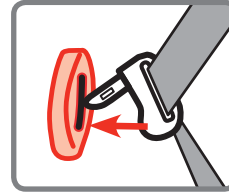

2. Or the buckle tongues can be placed into the slots in the harness holders as shown.



5. Place Child in Child Restraint to Determine Proper Harness Fit

The child's bottom and back should be flat against the child restraint.

See page 5 for fit guidelines.

How Does Your Child Fit?

Use the guidelines below to determine if the buckle and harness strap are in the right place for your child.

REAR FACING

Buckle Position



Start in the 1st slot and adjust outward as your child grows. Buckle should be used in slot closest to your child. The buckle should not be underneath or behind your child. 1st or 2nd slot **MUST** be used.

Harness Strap Position



Always choose the shoulder harness slots that are closest to your child's shoulder height. Harness strap **MUST** be at or slightly below shoulders.

If the lower shoulder harness slots for smaller infants are above the child's shoulders with the headrest in the lowest position, **do not** use this child restraint.

FORWARD FACING

Buckle Position



Start in the 1st slot and adjust outward as your child grows. Buckle should be used in slot closest to your child. The buckle should not be underneath or behind your child. Any slot can be used.

Harness Strap Position



Always choose the shoulder harness slots that are closest to your child's shoulder height. Harness strap **MUST** be at or slightly above shoulders.

If the upper shoulder harness slots are below the child's shoulders with the headrest in the highest position and the child weighs at least 40 lb (18 kg) and is at least 4 years old, you must convert the child restraint to a booster seat.

To change buckle position, see pages 6-7.

To adjust headrest/harness height, see page 8.

To make adjustments for smaller infants, see pages 9-11.

Changing Position of Buckle

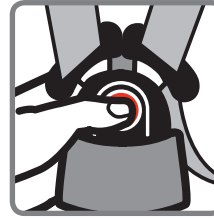

1. Unbuckle Harness

Press in towards the top of the red button.

Pull buckle tongues out.

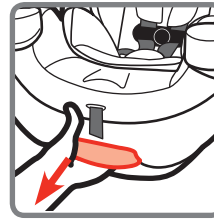

2. Fully Recline the Child Restraint

Pull out on recline handle and push top of child restraint back.

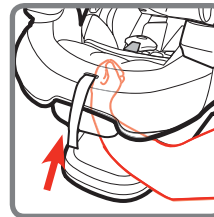

3. Locate Buckle's Metal Retainer

Reach under the seat between the base and shell and through the recline handle.

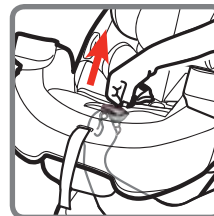

4. Rotate Metal Retainer and Push It Up Through Shell and Pad

continued on next page

Adjusting Headrest/Harness Height



- 5. From Top of Seat, Pull Buckle Out of Shell and Pad**

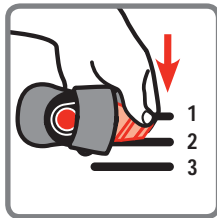

- 6. Insert Buckle's Metal Retainer into Slot Closest to Child**

Buckle **MUST** face out. You **MUST** use the 1st or 2nd buckle slots when child restraint is used rear facing. Any slot can be used when forward facing.

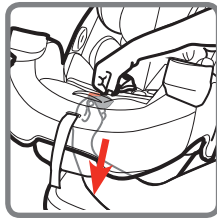

- 7. Reach Under the Seat Between Base and Shell and Through Recline Handle**

Pull metal retainer completely through pad and shell.



- 8. Check Buckle**

Pull up on buckle to make sure it is secured. The buckle **MUST** not pull out.

⚠ WARNING: Failure to place buckle's metal retainer completely through pad and shell can result in serious injury or death.

7

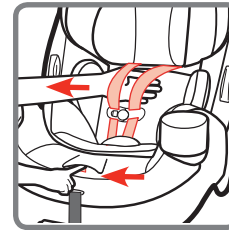

- 1. Fully Loosen Harness Straps**

Push down on harness release lever (under flap on front of seat pad) while pulling out on harness straps as shown.

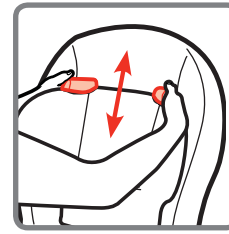

- 2. To Adjust Headrest/Harness Height**

Rotate headrest/harness adjustment levers inward.

Move the headrest up or down to the proper height for your child. **See page 5 for fit guidelines.**

Release it into slot to lock. Make sure it is securely locked into place.

⚠ WARNINGS: Make sure that the harness height is correct for your child's size.



Do not use this child restraint rear facing unless the top of your child's head is at least 1 in. (2.5 cm) below the top of the child restraint's headrest.



Do not use this child restraint forward facing if the tops of your child's ears are above the top of the child restraint's headrest.

Failure to follow these steps can result in serious injury or death.

8



Harness System Adjustments for Smaller Infants

When using the lower shoulder harness slots for smaller infants, you **MUST** use the body pillow and the headrest **MUST** be in the lowest position.

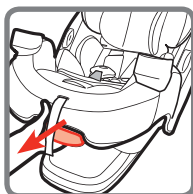

1. With Buckle in the 1st Slot, Fully Recline the Seat

If you need to move the buckle to the 1st slot, see page 6.

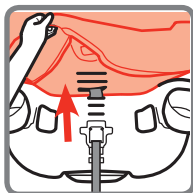

2. Lift Pad Off of Front of Child Restraint



3. From Bottom of Seat, Pull Metal Retainer Down and Push It Up into Middle Slot As Shown



4. From Top of Seat, Lay the Metal Retainer Flat Against the Shell As Shown



5. Replace Pad and Check Buckle

Pull up on buckle to make sure it is secured. The buckle **MUST** not pull out.

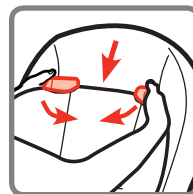

6. Adjust the Headrest to the Lowest Position

The headrest **MUST** be in the lowest position.

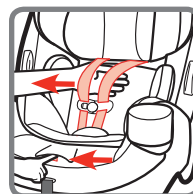

7. Fully Loosen Harness Straps

Push down on harness release lever (under flap on front of seat pad) while pulling out on harness straps as shown.



8. From Back, Remove Harness Strap Loops From Splitter Plate

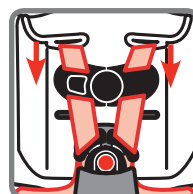

9. Pull Harness Straps Out of Upper Shoulder Harness Slots

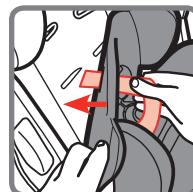

10. Pull Body Pillow Forward Away from Seat

Thread harness straps through slots in pillow.

You **MUST** use the body pillow.

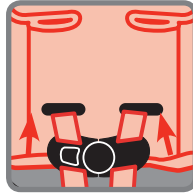

11. Pull Bottom of Headrest Pad Off of Headrest

Thread harness straps through slots in headrest pad.

Thread harness straps through lower shoulder harness slots in headrest and through the slots in seat back (shell).

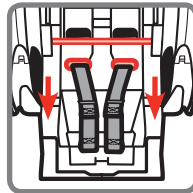

12. From the Back, Pull Harness Straps Through Shell

Harness straps **MUST** be in shoulder harness slots **BELOW** the metal bar as shown. **DO NOT** twist harness straps.



13. Attach 2nd Harness Strap Loops to Splitter Plate As Shown

Sewn ends of the harness strap loops **MUST** face towards you.

DO NOT twist harness straps or harness adjustment strap.

Make sure the same harness strap loops are fitted **COMPLETELY ON** both sides of the splitter plate.

Replace headrest pad around bottom of headrest.

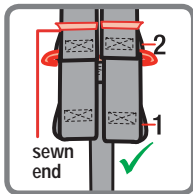

Correct

⚠ WARNINGS: Harness system must be installed correctly. The harness strap must be returned to the upper shoulder harness slots as your child grows.

Failure to follow these steps can result in serious injury or death.

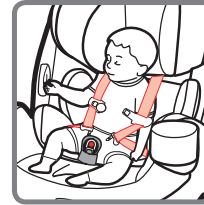

1. Place Child in Child Restraint

The child's bottom and back should be flat against the child restraint.

Position harness strap over child's shoulders and upper thighs.

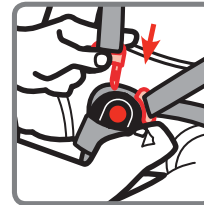

2. Buckle Harness

Push buckle tongues into buckle until you hear them "click."

Pull up on harness strap to make sure buckle is locked.

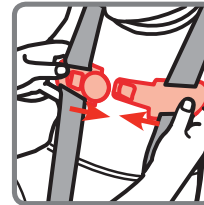

3. Close Chest Clip

Insert right half of chest clip into left half and snap together.

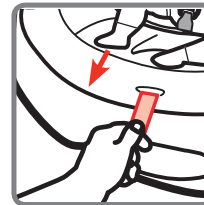

4. Tighten Harness

Pull on harness adjustment strap to tighten harness snugly.



5. Position Chest Clip

The chest clip must be placed at mid-chest (even with armpits) and away from the child's neck.

Reclining Child Restraint



6. Check Harness Tightness

Try to pinch the harness at the shoulders vertically between index finger and thumb as shown.

If your fingers slip off, the harness is tight enough.

If you can pinch the harness strap, tighten more. The harness straps should be snug throughout their length.

A snug strap should not allow any slack. It lies in a relatively straight line without sagging. It does not press on the child's flesh or push the child's body into an unnatural position.

⚠ WARNINGS: Failure to fasten and tighten the harness system correctly may allow the child to be ejected from the child restraint in a crash or sudden stop causing serious injury or death.



Do not mistake comfort for safety. Harness system must be snugly adjusted.

DO NOT put snowsuits or bulky garments on your child when placing them in the child restraint.

Bulky clothing can prevent the harness straps from being tightened properly.

To Remove Child From Child Restraint:

1. Loosen Harness Strap
2. Unbuckle Harness
3. Release Chest Clip
4. Remove Child

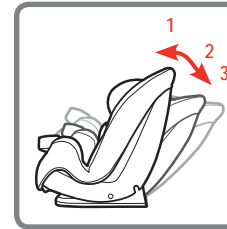

This child restraint has 3 positions:

Rear Facing - 3 or 2

For children who cannot sit up unassisted, the level line on shell **MUST** be parallel with the ground using either position 3 or 2.

For children who can sit up unassisted, you may rotate the child restraint to be more upright.

Forward Facing - 1 Upright

Booster Seat - 1 Upright

NOTE: When forward facing, the reclined positions are to be used only to install the child restraint and booster seat flush against the vehicle seat back. Vehicle seat back must be upright.

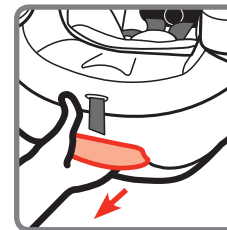

How to Change Positions

To recline, pull out on recline handle and push top of child restraint back.

For upright, pull out on recline handle and pull top of child restraint forward.



Storing Harness System

Only store the harness system when converting child restraint into a booster seat.

To remove accessories, see page 24.

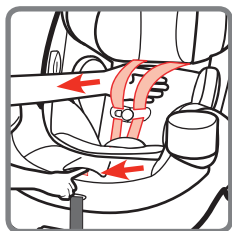

1. Fully Loosen Harness Straps

Push down on harness release lever (under flap on front of seat pad) while pulling out on harness straps as shown.



2. Unbuckle Harness

Press in towards the top of the red button.

Pull buckle tongues out.

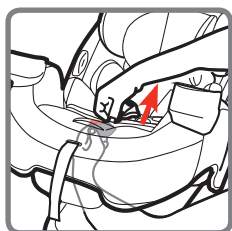

3. Locate Buckle's Metal Retainer

Fully recline the child restraint and reach under the seat between the base and shell and through the recline handle. Rotate metal retainer and push it up through shell and pad.

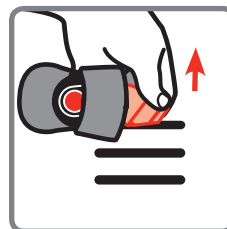

4. From Top of Seat, Pull Buckle Out of Shell and Pad

Store the buckle in a safe place for future use.

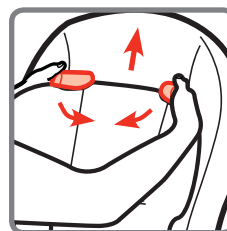

5. Adjust Headrest to Highest Position

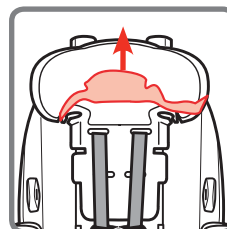

6. Pull Headrest Pad Off Bottom of Headrest As Shown

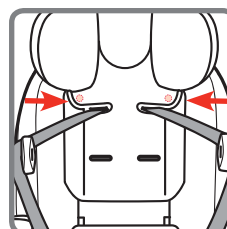

7. Undo Fasteners on Seat Pad As Shown

Removing Seat Pad for Cleaning

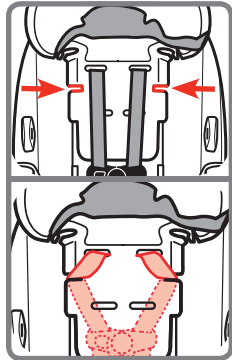

- 8. Thread Harness Straps into Slots on Sides of Headrest As Shown**

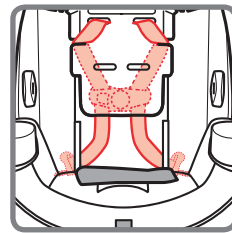

- 9. Place Chest Clip, Harness Straps, and Buckle Tongues Behind the Headrest and Seat Pad As Shown**

Push chest clip up so it is behind the headrest.

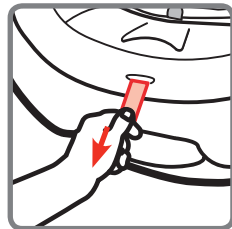

- 10. Tighten Harness**

Pull on harness adjustment strap to remove any slack from the harness system.

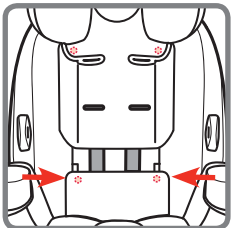

- 11. Pull Headrest Pad Down and Wrap Around Bottom of Headrest**

Attach fasteners on seat pad.

You DO NOT need to remove the harness system to remove the pad from the shell.

To remove accessories, see page 24.

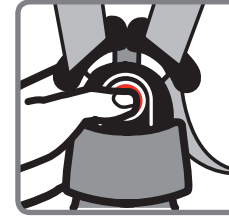

- 1. Unbuckle Harness**

Press in towards the top of the red button.

Pull buckle tongues out.

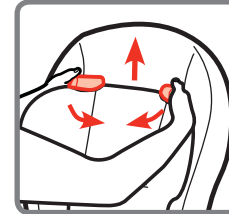

- 2. Adjust the Headrest to the Highest Position**

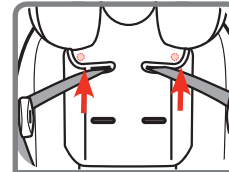

- 3. Undo Fasteners on Headrest Pad As Shown**

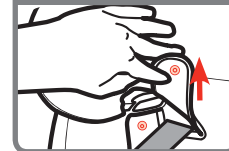

- 4. Pull Elastic Straps on Headrest Pad Over Headrest/Harness Adjustment Levers As Shown**

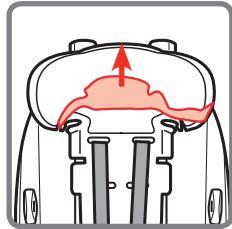

5. Pull Headrest Pad Off Bottom of Headrest As Shown

Remove headrest pad from shell.

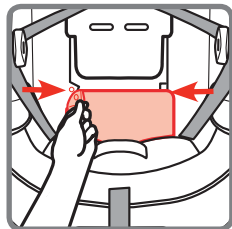

6. Undo Fasteners on Seat Pad As Shown

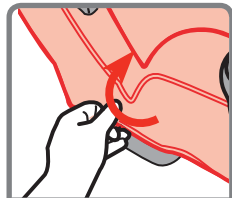

7. Pull Pad Off Sides and Bottom of Shell

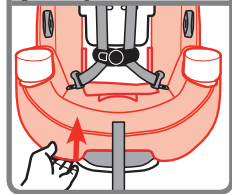

8. Pull Pad Down and Off of Bottom of Harness Holders

Pull up to remove completely.



9. From the Top, Pull Pad Off of Shell

⚠ WARNINGS: Do not use child restraint without the seat pad. Failure to do this can result in serious injury or death.

Cleaning Pad and Accessories

Machine wash separately with cold water on a gentle cycle. Make sure harness covers are closed so fastening strips are not exposed. Do not use bleach. Tumble dry separately for 10-12 minutes on low heat. Remove immediately.

Cleaning Harness Strap

Spot clean using warm sudsy water and damp cloth.

Replacing Pad

Adjust the headrest to the highest position. Starting from the bottom, gently pull headrest pad onto headrest. Place elastic straps on headrest pad around headrest/harness adjustment levers. Slide harness straps into slots in pad. Attach fasteners.

Starting from bottom of child restraint, slip pad on shell. Pull harness adjustment strap through pad. Wrap pad around bottom and sides of shell. Push harness holders through slots in pad. Push pad behind headrest. Wrap around the top of shell. Slide harness straps into slots in pad. Attach fasteners.



Installing Harness System

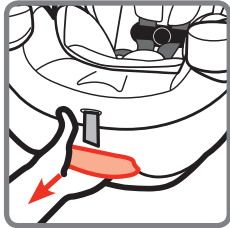

1. Fully Recline the Child Restraint

Pull out on recline handle and push top of child restraint back.

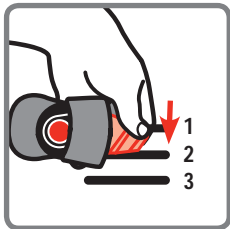

2. Insert Buckle's Metal Retainer into Slot Closest to Child

Buckle **MUST** face out. You **MUST** use the 1st or 2nd buckle slots when child restraint is used rear facing. Any slot can be used when forward facing.

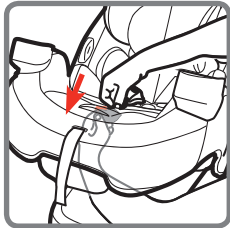

3. Reach Under Seat Between Base and Shell and Through Recline Handle

Pull metal retainer completely through pad and shell.

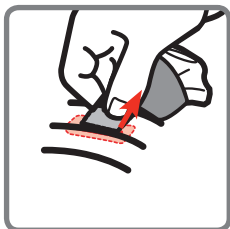

4. Check Buckle

Pull up on buckle to make sure it is secured. The buckle **MUST** not pull out.

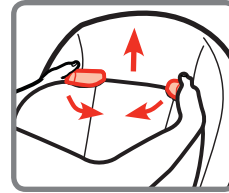

5. Adjust Headrest to Highest Position

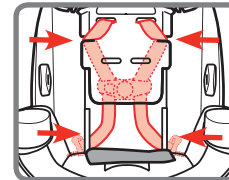

6. Undo Fasteners on Seat Pad and Pull Headrest Pad Off Bottom of Headrest

Unthread harness straps from slots on side of headrest.

Loosen harness straps.

Pull chest clip, harness straps, and buckle tongues out from behind the headrest and seat pad.

Slide harness straps into slots in headrest pad.

Attach seat pad fasteners.

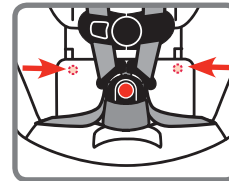

If you have removed the harness straps from the splitter plate, and the buckle tongues and chest clip have been unthreaded from the harness straps, follow the steps below to rethread them.

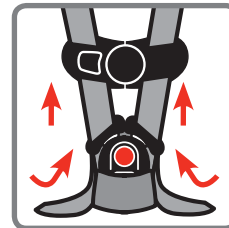

1. Thread Buckle and Chest Clip

Harness strap ends go through the **back** of buckle tongues and through the chest clip **front to back** as shown.

Accessories on Select Models

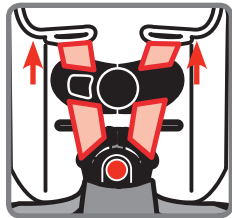
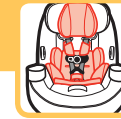

2. Thread Harness Straps into Shoulder Harness Slots

If you will be using the lower shoulder harness slots for smaller infants, see pages 9-11.

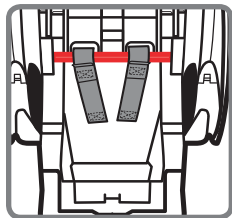

3. From Back, Thread Harness Straps OVER Metal Bar

DO NOT twist harness straps.

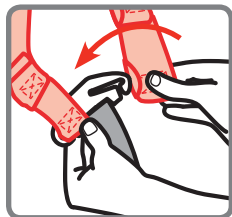

4. Attach 1st Harness Strap Loops to Splitter Plate As Shown

Sewn ends of the harness strap loops **MUST** face towards you.

DO NOT twist harness strap or harness adjustment strap.

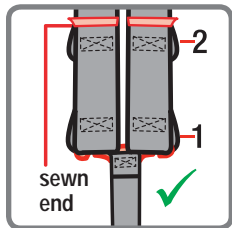

Correct

⚠ WARNINGS: Harness system must be installed correctly. Failure to follow these steps can result in serious injury or death.

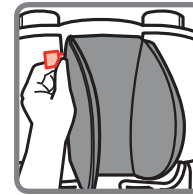

Head Pillow

To remove head pillow, gently pull tabs on back of head pillow out of headrest pad.

To attach the head pillow, slide the tabs on back of head pillow into headrest pad.

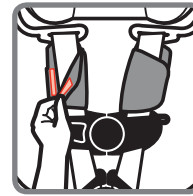

Harness Covers

Harness covers help provide comfort to the neck. If harness covers will not allow proper positioning of the chest clip or interfere with getting a tight enough fit for a smaller baby, remove and do not use.

Store until child is large enough to use these harness covers while maintaining a properly fitting harness.

To remove harness covers, pull the fastening strips apart and remove harness covers.

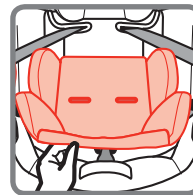

Body Pillow

When using the lower shoulder harness slots for smaller infants, you **MUST** use the body pillow.

To remove body pillow, pull buckle through the slot in pillow and slide pillow out from behind the harness straps.

Or from the back of seat, remove harness strap loops from splitter plate. From the front, pull harness straps out of shell and body pillow. Pull buckle through slot in pillow. Rethread harness straps: For lower shoulder harness slots for smaller infants, see pages 9-11. For upper shoulder harness slots, see page 23.

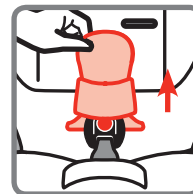

Buckle Cover

To remove buckle cover, slide the ends out of the slot in pad. Pull up and off of the buckle.



Child Restraint Use

- Never take your child out of the child restraint while the vehicle is moving.
- Never leave child unattended.
- Placing your child in a hot child restraint may result in burns.
- Do not use a child restraint with damaged or missing parts.
- Do not use cut, frayed or damaged harnesses.
- Do not substitute parts or try to modify the child restraint in any way.
- Do not lubricate buckles and fasteners.
- Do not use any child restraint accessory except those approved by Dorel Juvenile Group.
- Never allow any child to play with this child restraint; it is not a toy.
- Do not remove or cover up any of the warning labels or other labels on the child restraint.
- Read all instructions for additional warnings.
- On the side of the child restraint there is a date of manufacture label. Do not use this child restraint more than 10 years after the date of manufacture.

Installation in Vehicle

- Check the vehicle belt or lower anchor belt before each use. Use only if the belt is tightened properly and locked securely in place.
- This child restraint should be securely belted in the vehicle even when not in use. In a crash or sudden stop, an unsecured child restraint could injure occupants.
- Do not use a child restraint that has been in a crash. You must get a new child restraint.

Vehicle Seating Position



Never place a child rear facing in a seating position with an active frontal air bag.

Check the vehicle owner's manual for more information about air bag/child restraint use.



Use the child restraint only on vehicle seats that face forward.

Do not use on seats that face the sides or rear of the vehicle.



Use the center seating position if possible.

For vehicles without a back seat, refer to your vehicle owner's manual.

If you are not sure where to place the child restraint in your vehicle, consult your vehicle owner's manual, contact Dorel Juvenile Group Consumer Care Department, or visit your local Child Passenger Inspection Station. Go to <http://www.safercar.gov/cpsApp/cps/index.htm> to find your closest station.



Children are safer when properly restrained in rear seating positions than in the front seating positions.

According to National Highway Traffic Safety Administration information, children in rear seating positions are statistically safer, whether you have air bags, advanced air bags, or no air bags at all.

To avoid your child being seriously burned, take the following precautions:

1. Park in the shade or where sun does not directly hit the child restraint.
2. Cover the child restraint with a sheet or blanket when not in use.
3. Check for hot seat and buckles before placing child in child restraint.

To help protect your vehicle seat's upholstery from damage, use a single layer towel underneath and behind child restraint.



Choosing Lower Anchor or Vehicle Belts

Your vehicle's features may be considerably different than those pictured here.

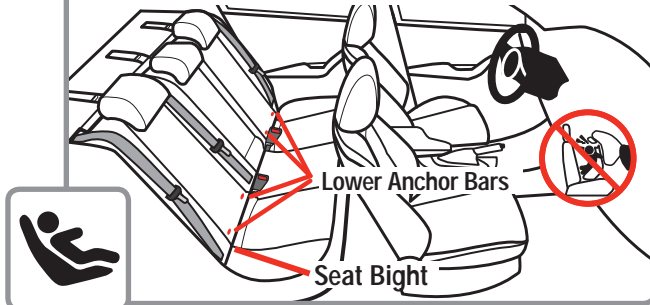

The LATCH System

The lower anchors of LATCH (Lower Anchors and Tethers for Children) is a universal system for installing child restraints without using vehicle seat belts. The lower anchor system can ONLY be used in vehicles that have the lower anchor bars installed and designated LATCH seating positions. Most vehicles manufactured after September 2002 are equipped with lower anchor bars.

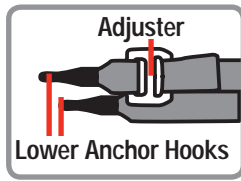

Lower Anchor Hooks

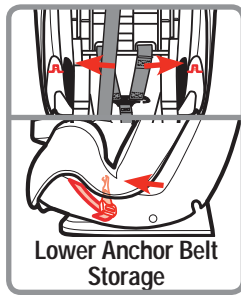

Lower Anchor Belt Storage

Check your vehicle owner's manual to see which seating positions may be equipped with the LATCH system.

When installing this child restraint with vehicle belts or when using as a booster seat, the lower anchor hooks and belt MUST be properly stored.

To store the lower anchor belt on this child restraint: Thread lower anchor belt through rear-facing belt path. Then attach hooks to storage attachments as shown. Gently pull free end of belt to remove slack.

Your vehicle's features may be considerably different than those pictured here.

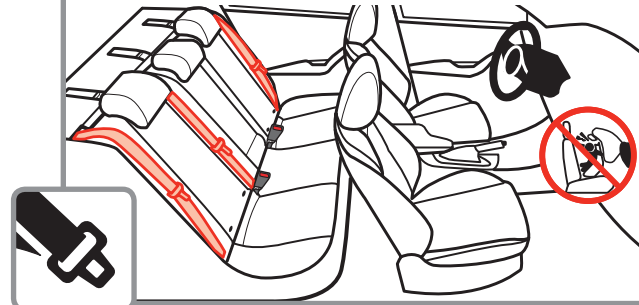

Vehicle Belts

If lower anchors are not an option, you must use the vehicle seat belt system to install the child restraint.

There are some vehicle belts that will not work with a child restraint or will require special attention.

Check your vehicle owner's manual for specific instructions.

⚠ WARNINGS: When used correctly the lower anchor belt or vehicle belts are equally safe. Do not use both the lower anchor belt and vehicle belt at the same time.



Knowing Your Vehicle Belts

Not all vehicle belts and seating positions will work with child restraints. Please follow the following steps to understand how to lock a child restraint with a vehicle belt.

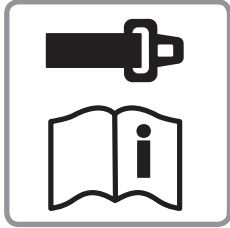

1. You MUST Review Your Vehicle Owner's Manual

Your vehicle owner's manual will let you know what vehicle belts and seating positions child restraints can be installed in.



2. Determine How the Child Restraint Will Be Locked Into Place

The vehicle belt **MUST NOT** loosen after tightening.

This means there needs to be a way to lock the vehicle belt.

The ways this can be done are:

- By using the seat belt's retractor; or
- By using the seat belt's latch plate.

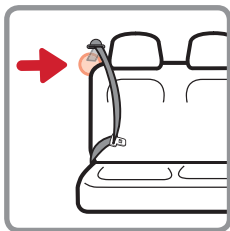

3. Check the Retractor

Retractors pull seat belts into stored positions and lock the belt to hold passengers in place.

A retractor is most likely how you will be locking a child restraint into place.

See the next page for some common types of vehicle belt retractors that will work with this child restraint.

Types of Retractors

Switchable Retractor (most vehicles have this type)



This retractor can be switched to a locking mode.

You **MUST** have the retractor in the locking mode to use the seat belt with this child restraint.

Switching to locking mode: Slowly pull the shoulder belt all the way out, then let it go back in an inch or two.

As it goes back, in you will most likely hear a ratcheting sound.

Gently pull the belt to see if it has locked. You will not be able to pull any more belt out if the lock has engaged.

Automatic Locking Retractor



This retractor always locks.

It will automatically lock after slowly pulling the seat belt out at least halfway and letting the belt go back into the retractor an inch or two.

Emergency Locking Retractor

See Step 4, "Check the Latch Plates," on next page.

If the retractor does not lock, it is most likely an Emergency Locking Retractor. These retractors only lock during a sudden stop or collision.

You will need to determine if your seat belt's latch plate can lock the belt. See Step 4, "Check the Latch Plates," on next page.

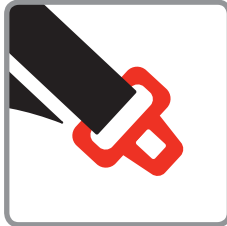

4. Check the Latch Plates

Latch plates are the part of the seat belt that goes into the buckle.

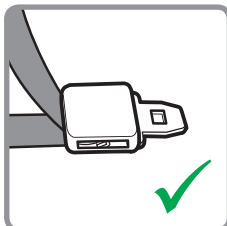

Locking Latch Plate

Hold the lap belt with one hand and with your other hand grasp the tongue of the latch plate (the part that goes inside the buckle). Pull the latch plate straight out in line with the lap belt.

If the latch plate does not slide up and down the vehicle belt, it is a **locking latch plate**.

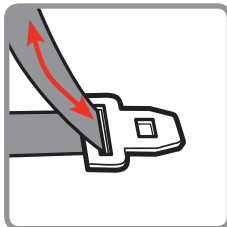

Emergency Locking Retractor with a Sliding Latch Plate

If the latch plate slides up and down the vehicle belt, it is a **sliding latch plate**.

Sliding latch plates easily slip between the lap and shoulder portions of the belt.

If you have an Emergency Locking Retractor with a Sliding Latch Plate, you **MUST** use a locking clip to install the child restraint. See pages 55-56.

Never Use With This Child Restraint

Emergency Locking Retractor Lap Only Belt	✗
Inflatable Seat Belts	✗

This restraint is certified for aircraft use when used with the internal harness.

This child restraint is not certified for aircraft use when used as a booster seat because aircraft seats do not have shoulder belts.

Install the child restraint in a window seat to avoid blocking the aisle. If the aircraft lap belt is too short, ask the flight attendant for a belt extender.

Use only on forward facing aircraft seats.

Contact the airline for their specific policies.



Some airlines may ask to see a label stating that this child restraint is certified for aircraft use.

There is an airplane certification label located on the side of this child restraint as shown.

⚠ WARNING: Store the lower anchor belt and tether strap when using the aircraft belts.



Rear Facing Aircraft Installation

For rear facing installation follow pages 39-42.



Forward Facing Aircraft Installation

For forward facing installation follow pages 49-51.



Rear Facing

Lower Anchor Belt Installation



5-40 lb (2.3-18 kg)
19-40 in. (48-101.6 cm)



 Lower Anchor Belt

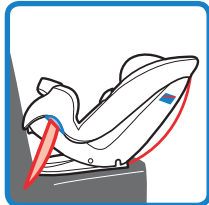

 Lap Belt

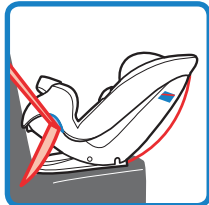

 Lap/Shoulder Belt



⚠ WARNINGS: Never install a rear facing child restraint in the front seat of a vehicle equipped with an active frontal airbag.

This child restraint **MUST** always face the rear of the vehicle when the child is less than 1 year old.

The American Academy of Pediatrics recommends that children should remain rear facing until they are at least 2 years old. Please talk to your doctor about which is the best option for your child.

⚠ WARNINGS: Do not use the lower anchor belt along with the vehicle lap or lap/shoulder belt.

Check lower anchor belt before each use. Use only if the belt can be tightened properly and securely.

Do not fasten multiple lower anchor hooks on the same lower anchor bar in the vehicle.

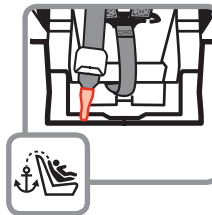

Store the tether hook when used rear facing. Attach the tether hook to storage attachment as shown and gently tighten to remove slack.

Failure to follow these warnings can result in serious injury or death.

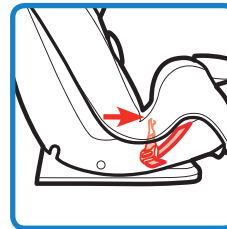

1. Remove Lower Anchor Belt from Storage Location

Or if the lower anchor belt was used forward facing, remove it from the forward-facing belt path so both hooks are on the same side of the seat.

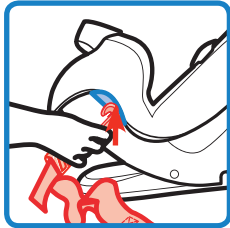

2. Route Lower Anchor Belt Through Rear-Facing Belt Path

Do not twist belt.
The lower anchor belt adjuster can be on either side.

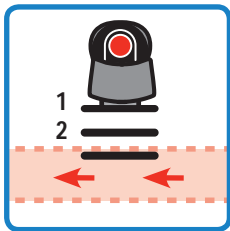

3. Pull Lower Anchor Belt Across to Opposite Side

Do not twist belt.
Belt **MUST** be in front of buckle strap. You **MUST** use the 1st or 2nd buckle slot. Do not place belt over child's legs.

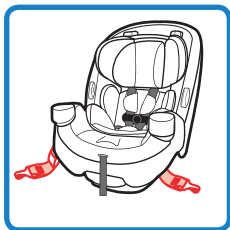

4. Finished Lower Anchor Belt Routing

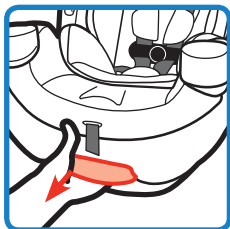

5. Recline the Child Restraint

Pull out on recline handle and push top of child restraint back.

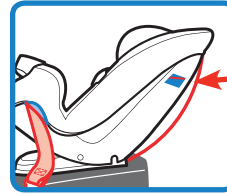

6. Place Child Restraint Rear Facing in Back Seat

For children who cannot sit up unassisted, the level line on shell **MUST** be parallel with the ground.

For children who can sit up unassisted, you may rotate the child restraint to be more upright in position 2.

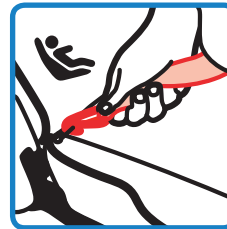
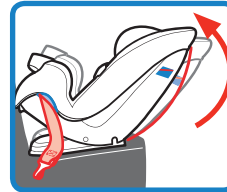

7. Attach Lower Anchor Hooks to Vehicle's Lower Anchors

Review your vehicle owner's manual for lower anchor locations and lower anchor belt use.

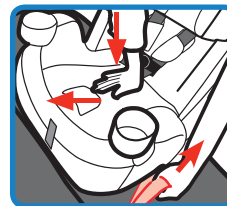

8. Tighten Belt

Place hand in child restraint.
Firmly push child restraint down and back towards the vehicle seat back while pulling free end of belt to tighten.

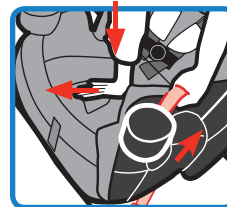

It may be easier to pull pad away from shell and tighten the belt through the belt path opening as shown.



9. Check Belt Tightness

Hold child restraint at the belt path with your weakest hand. Push and pull from side to side. It should not move more than 1 in. (2.5 cm).

If it moves more than 1 in. (2.5 cm), you can try:

- A. Pulling the belt tighter.
- B. Reinstalling the child restraint.
- C. Changing to a different seating location.
- D. Switching to vehicle belt installation.

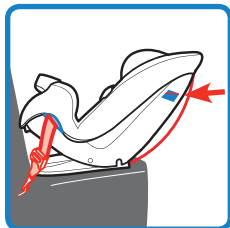

10. Secure Child in Child Restraint

Recheck level line.

Repeat steps 6-10 if not reclined correctly.

NOTE: You may need to place a large rolled towel(s) or foam pool noodle(s) under front of child restraint to help achieve the correct recline angle.

Check often to be sure padding is still in place and the belt is tight.

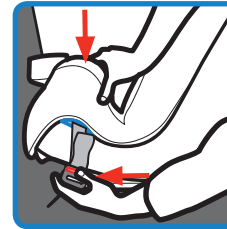

To Release Lower Anchor Belt

Remove child from child restraint.

Remove tension from the lower anchor belt by pushing down on side of child restraint with the lower anchor belt adjuster. Then press the adjuster button to loosen belt.

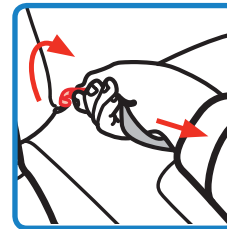

Unhook from anchor by squeezing spring lever on hook, pushing hook back into the seat bight, and twisting. Then pull it out of the vehicle seat.

Store lower anchor belt when not in use. See page 27.



Vehicle Belt Installation

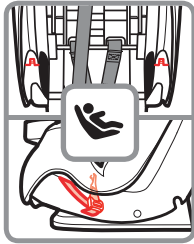

⚠ WARNINGS: Do not use the lower anchor belt along with the vehicle lap or lap/shoulder belt. Secure lower anchor hooks to storage attachments as shown when installing with vehicle belts.

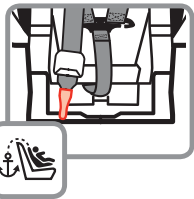

Store the tether hook when used rear facing. Attach the tether hook to storage attachment as shown and gently tighten to remove slack.

Check vehicle belt before each use. Use only if the belt can be tightened properly and locked securely in place.

Failure to follow these warnings can result in serious injury or death.

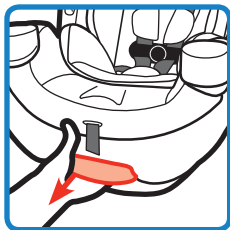

1. Recline the Child Restraint

Pull out on recline handle and push top of child restraint back.

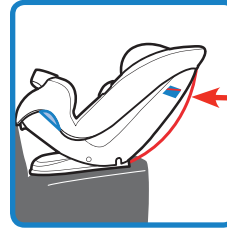

2. Place Child Restraint Rear Facing in Back Seat

For children who cannot sit up unassisted, the level line on shell **MUST** be parallel with the ground.

For children who can sit up unassisted, you may rotate the child restraint to be more upright in position 2.

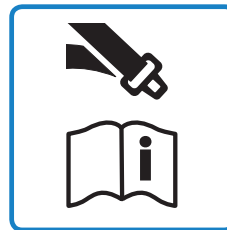
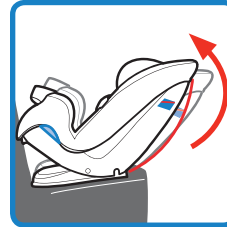

3. Check if Your Vehicle Belts Will Work With This Child Restraint

This is very important because **not all vehicle belts will work with child restraints.**

Review pages 29-31 and your vehicle owner's manual to determine what kind of vehicle belt you have and how to lock a child restraint in place.

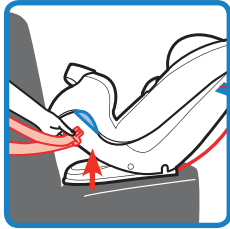

4. Route Vehicle Lap or Lap/Shoulder Belt Through Rear-Facing Belt Path

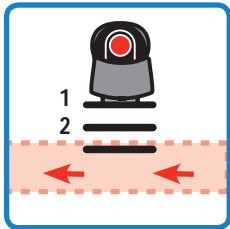

5. Pull Vehicle Belt Across to Opposite Side

Do not twist belt. Belt **MUST** be in front of buckle strap.

You **MUST** use the 1st or 2nd buckle slot. Do not place belt over child's legs. Buckle vehicle belt.

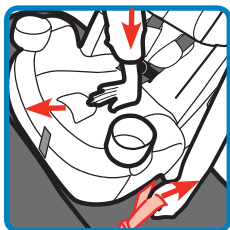

6. Tighten Belt

Place hand in child restraint.

Firmly push child restraint down and back towards the vehicle seat back while pulling shoulder belt or the free end of lap belt to tighten.

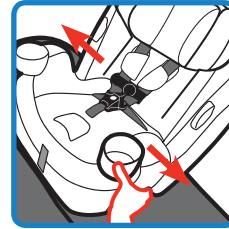

7. Check Belt Tightness

Hold child restraint at the belt path with your weakest hand.

Push and pull from side to side.

It should not move more than 1 in. (2.5 cm).

If it moves more than 1 in. (2.5 cm), you can try:

- A. Pulling the belt tighter.
- B. Reinstalling the child restraint.
- C. Changing to a different seating location.
- D. Switching to the lower anchor belt installation if lower anchors are available in your vehicle.

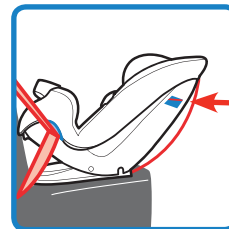

8. Secure Child in Child Restraint

Recheck the level line. Repeat steps 2-8 if not reclined correctly.

NOTE: You may need to place a large rolled towel(s) or foam pool noodle(s) under front of child restraint to help achieve the correct recline angle. Check often to be sure padding is still in place and the belt is tight.

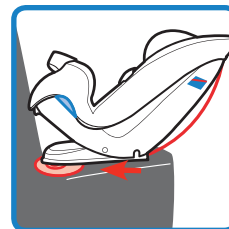





Forward Facing

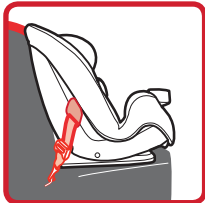

22-65 lb (10.1-29 kg)
29-49 in. (73.6-125 cm)
At least 1 year old



 **Lower Anchor Belt with Tether**
up to 40 lb (18 kg)



 **Lap Belt with Tether**
up to 65 lb (29 kg)



 **Lap/Shoulder Belt with Tether**
up to 65 lb (29 kg)

⚠ WARNINGS: In this child restraint your child **MUST** be at least 1 year old before they sit forward facing.

The American Academy of Pediatrics recommends that children should remain rear facing until they are at least 2 years old.

Please talk to your doctor about which is the best option for your child.

Tether Use



You **MUST** always attach, adjust, and secure the top anchorage (tether) strap when installing the child restraint forward facing with internal harness. Tethers improve the installation and stability of child restraints and reduce the risk of injury.

Attach the tether hook to the tether anchor designated by your vehicle manufacturer for that seating position. Check your vehicle owner's manual for more information.

If the seating position does not have a tether anchor, use a different seating position or see your dealer or a qualified mechanic and have one installed.

⚠ WARNINGS: Do not fasten multiple tether hooks on the same tether anchor in the vehicle.

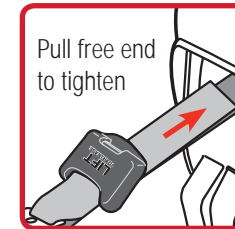

Adjusting Tether Strap

To tighten: After the child restraint is locked into place with lower anchor belt or vehicle belt, push down on child restraint and gently pull on free end of tether.

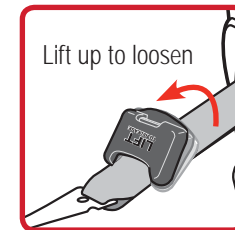

To loosen: Lift up on tether lock adjuster and push it towards tether hook.



Storing Tether Strap

When installing rear facing, using as a booster, or when not in use, attach the tether hook to its storage attachment on the base as shown. Gently tighten to remove slack.



Lower Anchor Belt Installation

⚠ WARNINGS: Do not use the lower anchors of the child restraint anchorage system (LATCH system) to attach this child restraint when restraining a child weighing more than 40 lbs (18 kg) with the internal harnesses of the child restraint.

The vehicle belt must be used for installation if your child weighs more than 40 lb (18 kg).

Do not use the lower anchor belt along with the vehicle lap or lap/shoulder belt.

Check the lower anchor belt before each use. Use only if the belt can be tightened properly and securely.

Do not fasten multiple lower anchor hooks on the same lower anchor bar in the vehicle.

Failure to follow these warnings can result in serious injury or death.



1. Remove Lower Anchor Belt from Storage Location

Remove it from the rear-facing belt path so both hooks are on the same side of the seat.

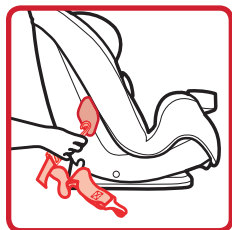

2. Route Lower Anchor Belt Through Forward-Facing Belt Path

Do not twist belt.

The lower anchor belt adjuster can be on either side.

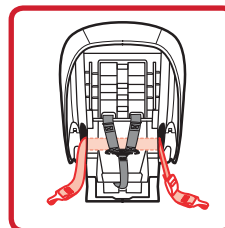

3. Finished Lower Anchor Belt Routing

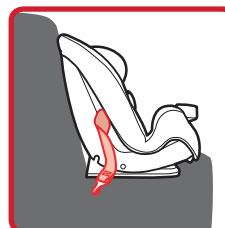

4. Place Child Restraint Forward Facing Flush Against Vehicle Seat Back

Put the child restraint into position 1.

NOTE: Do not use any recline positions except to make the child restraint flush against the vehicle seat back.

Vehicle seat back must be upright.

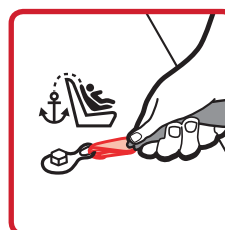

5. Loosely Attach Tether Hook to Vehicle's Tether Anchor

Check vehicle owner's manual for specific location.



6. Attach Lower Anchor Hooks to Vehicle's Lower Anchors

Review your vehicle owner's manual for lower anchor locations and lower anchor belt use.



7. Tighten Belt

Place hand in child restraint.

Firmly push down while pulling free end of belt to tighten.

It may be easier to pull the free end of the belt parallel with the belt path through the Easy Access Belt Path panel in pad as shown.



8. Tighten Tether

Push firmly on the back of the seat and pull the tether strap to remove all slack and create tension on the strap.

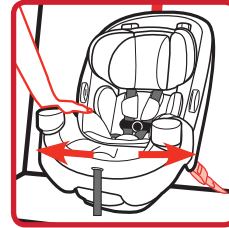

9. Check Belt Tightness

Hold child restraint at the belt path with your weakest hand.

Push and pull from side to side.

It should not move more than 1 in. (2.5 cm).

If it moves more than 1 in. (2.5 cm), you can try:

- A. Reinstalling the child restraint.
- B. Putting your knee in the seat and pulling the belt tighter.
- C. Changing to a different seating location.
- D. Switching to vehicle belt installation.

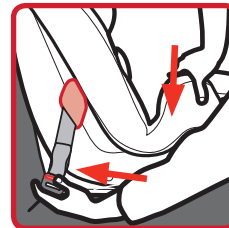

To Release Lower Anchor Belt

Remove child from child restraint.

Remove tension from the lower anchor belt by pushing down on side of child restraint with the lower anchor belt adjuster. Then press the adjuster button to loosen belt.

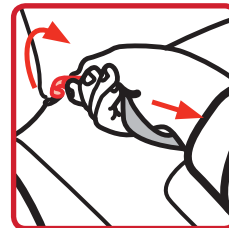

Unhook from anchor by squeezing spring lever on hook, pushing hook back into the seat, and twisting. Then pull it out of the vehicle seat.

Store lower anchor belt when not in use. See page 27.



Vehicle Belt Installation

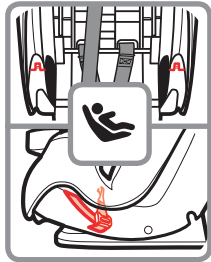

⚠ WARNINGS: Do not use the lower anchor belt along with the vehicle lap or lap/shoulder belt. Secure lower anchor hooks to storage attachments as shown when installing with vehicle belts.

Check vehicle belt before each use. Use only if the belt can be tightened properly and securely.

Failure to follow these warnings can result in serious injury or death.

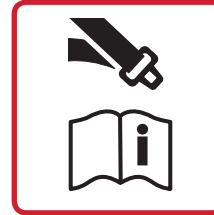

3. Check if Your Vehicle Belts Will Work With This Child Restraint

This is very important because **not all vehicle belts will work with child restraints.**

Review pages 29-31 and your vehicle owner's manual to determine what kind of vehicle belt you have and how to lock a child restraint in place.

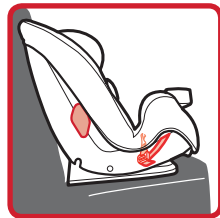

1. Place Child Restraint Forward Facing Flush Against Vehicle Seat Back

Put the child restraint into position 1.

NOTE: Do not use any recline positions except to make the child restraint flush against the vehicle seat back.

Vehicle seat back must be upright.



4. Route Vehicle Lap or Lap/Shoulder Belt Through Forward-Facing Belt Path

Do not twist belt. Buckle vehicle belt.

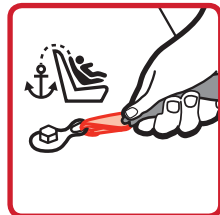

2. Loosely Attach Tether Hook to Vehicle's Tether Anchor

Check vehicle owner's manual for specific location.



5. Tighten Belt

Place hand in child restraint.

Firmly push down while pulling shoulder belt or the free end of lap belt to tighten.



6. Tighten Tether

Push firmly on the back of the seat and pull the tether strap to remove all slack and create tension on the strap.

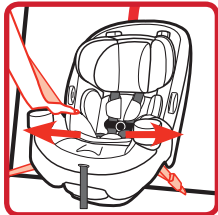

7. Check Belt Tightness

Hold child restraint at the belt path with your weakest hand.

Push and pull from side to side.

It should not move more than 1 in. (2.5 cm).

If it moves more than 1 in. (2.5 cm), you can try:

- A. Reinstalling the child restraint.
- B. Putting your knee in the seat and pulling the belt tighter.
- C. Changing to a different seating location.
- D. Switching to the lower anchor belt installation if lower anchors are available in your vehicle.



40-100 lb (18.1-45.4 kg)

43-52 in. (110.1-132.1 cm)

At least 4 years old



You **MUST** store the harness system (see pages 15-17) and remove accessories (see page 24) to use as a booster seat.

⚠ WARNINGS: Do not use the harness system when using as a booster seat.



Do not use this booster seat if the tops of your child's ears are above the top of the booster seat's headrest.



Use only the vehicle's lap and shoulder belt system when restraining the child in this booster seat.

Do not use only the lap belt when using this seat as a booster seat.

The shoulder belt must always be adjusted snugly across the child's chest. **NEVER** place the shoulder belt under the child's arms.

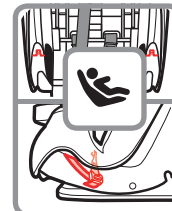

Do not use the LATCH system when using as a booster seat. Secure lower anchor belt and tether strap to their storage locations.

Failure to follow these warnings can result in serious injury or death.





Lap and Shoulder Belt Installation



1. Place Booster Seat Forward Facing Flush Against Vehicle Seat Back

Put the booster seat into position 1.

NOTE: Do not use any recline positions except to make the booster seat flush against the vehicle seat back. Vehicle seat back must be upright.



2. Place Child in Booster Seat

Tops of the child's ears should never be above the top of the headrest.

Adjust headrest if needed, see page 8.

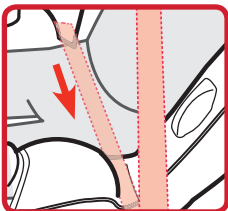

3. Position Lap Belt on Child

Route the lap belt portion of vehicle belt through the booster belt path as shown.

The lap belt should lay snugly across the child's upper thighs and not on the stomach.

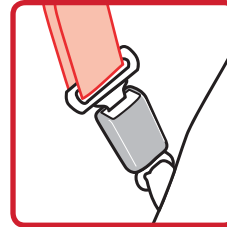
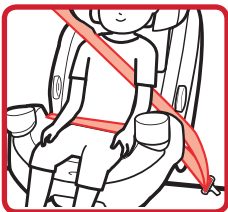

4. Buckle Vehicle Belt



5. Position Shoulder Belt on Child

Slide the shoulder belt under bottom of the Easy Out Harness Holder as shown.

Pull up on shoulder belt to tighten.

The shoulder belt should lay snugly across the center of the child's shoulder and across the chest and not on their face or neck.



To help position the shoulder belt, you may need to secure the shoulder belt in one of the two shoulder belt-positioning guides behind headrest pad.

NOTE: Use the shoulder belt positioning guide only if necessary to correctly position the shoulder belt on the child.

Check periodically to make sure your child has not moved out of position and loosened the shoulder belt.



Using a Locking Clip

You will rarely need to use a locking clip except in some older vehicles. Built-in child restraint locking systems have been required in vehicles since 1996, and many vehicles had these features even earlier. Review pages 29-31 and your vehicle owner's manual to determine if your vehicle belts require a locking clip.

If you need a locking clip immediately, they are likely available at an auto dealership, an auto store, or where you purchased this child restraint. You can also call us at 1-800-544-1108 for one.

A locking clip will not fix all types of seat belt problems. You **MUST** have a lap and shoulder belt to use a locking clip. **Do not use the locking clip when using this seat as a booster seat.**

For Rear Facing installation, follow pages 39-41 Warnings and Steps 1-6 before starting locking clip installation.

For Forward Facing installation, follow pages 49-51 Warnings and Steps 1-5 before starting locking clip installation.

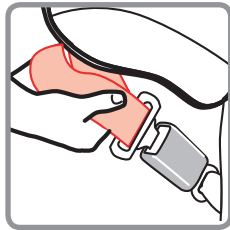

1. Determine Locking Clip Position

Grasp both vehicle belts together just behind the latch plate to mark the position for locking clip.

Unbuckle the belt.

NOTE: If the latch plate ends up just at the belt path opening so you

cannot grasp the vehicle belt at the latch plate, grasp the vehicle belts on the opposite side of the child restraint, as close to the latch plate as possible.

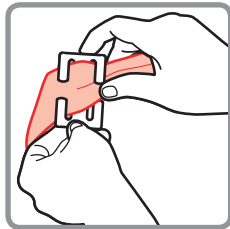

2. Attach Locking Clip

Thread both portions of the vehicle belt onto the locking clip, as close to the latch plate as possible.

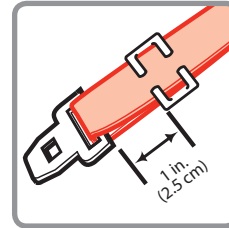

3. Position Locking Clip

It should be about 1 in. (2.5 cm) from vehicle belt's latch plate.

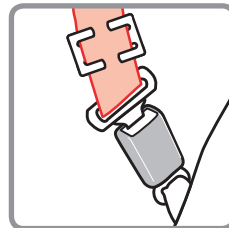

4. Rebuckle Vehicle Belt

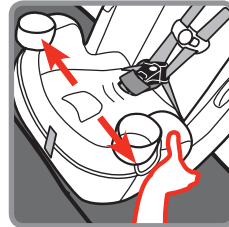

5. Check Belt Tightness

Hold child restraint at the belt path with your weakest hand.

Push and pull from side to side.

If it moves more than 1 in. (2.5 cm), try reinstalling the child restraint or try another seating location.

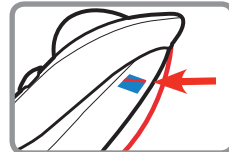

When installed rear facing, recheck the level line.



When installed forward facing, make sure to tighten the tether strap.

Remove the locking clip when the seat belt is not being used with a child restraint.

Dorel Juvenile Group Information

Thank you for choosing this child restraint. The DJG family is committed to creating child restraints with the most comfort and convenience available today.

Remember, parents are a child's first teachers and examples. If you always buckle your seat belt, your child will think it is the natural thing to do. Make it a firm rule that the vehicle does not go until everyone is buckled up. Make no exceptions.

No one can predict if use of a child restraint will prevent injury or death in a particular crash. However, when combined with careful driving, proper use of a child restraint can lower a child's risk of injury or death in most crashes.

Your child's safety is worth the time it will take to read and follow these instructions. After reading, if you still have questions or have any concerns with this child restraint, please contact our Consumer Care Department at:

Website: www.safety1st.com

Telephone: 1-800-544-1108

M-TH from 8 A.M. to 6 P.M. EST
FRI from 8 A.M. to 4:30 P.M. EST

Mailing Address:

Dorel Juvenile Group, Inc.
Consumer Care Department
P.O. Box 2609
Columbus, IN 47202-2609

Registration and Safety Notices

Please complete the postage-paid registration card that came with your child restraint, and send it to us. Child restraints could be recalled for safety reasons. You must register this restraint to be reached in a recall. Send your name, address, email address if available, the restraint's model number, and manufacturing date to:

Dorel Juvenile Group, Inc.
Consumer Care Department
PO Box 2609
Columbus, IN 47202-2609

or call 1-800-544-1108 or register online at www.djgusa.com/registration/carseat/us.

For recall information, call the U.S. Government's Vehicle Safety Hotline at 1-888-327-4236 (TTY: 1-800-424-9153), or go to <http://www.NHTSA.gov>.

Consumer: Just fill in your name, address and email. Please print (use dark ink).

Your Name _____

Your Street Address _____

City _____ State _____

Email (optional) _____

Model Number **Line Code** **Manufacture Date**

Model Number Line Code Manufacture Date

AB123CDE S1 CARSEAT 01/22/2015

L#11 B265035

Example of model number, manufacture date, and line code.

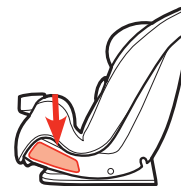

If you don't have the card or if your address changes, you will find the model number, manufacture date, and line code on the label located on side of shell.

Troubleshooting

1. Locate a Child Safety Seat Inspection Station for hands on training on how to use your child restraint:

Visit your local Child Passenger Inspection Station or go to <http://www.safercar.gov/cpsApp/cps/index.htm> to find your closest station.

2. If the child restraint buckle or harness release lever sticks or you cannot get the straps tight enough around child:

DO NOT LUBRICATE. Check around lever and retractor for dropped food, sticky spilled drinks, dirt, leaves, etc. Clean with warm water and/or remove object with tweezers. If you cannot get the harness to adjust and remain tight with the buckle securely locked, do not use the child restraint.

3. If your harness twists:

Straighten the harness each time you put your child in the child restraint to help prevent twisting. Lock the buckle and tighten harness so it will be ready for next use.

Replacement Parts Order Form

Complete the form. Your model number and manufacturer date code **MUST** be included on the form to ensure proper replacement parts. The codes can be found on a label on side of child restraint. Payment in U.S. dollars must accompany your order. Choose parts needed from the list on the next page. Return the form with payment to:

Dorel Juvenile Group, Inc.
Consumer Care Department
P.O. Box 2609
Columbus, IN 47202-2609

Please make money orders payable to Dorel Juvenile Group, Inc. Fill in the area on the next page to charge credit card. (Visa or MasterCard **only**). We do not accept cash, personal checks, or other credit cards. All outside of U.S. and Canada **MUST** use credit card.

Ship To: (Please Print)

Name: _____

Address: _____

City: _____

State/Province: _____ **Zip:** _____

Telephone: _____

Email Address: _____

We **MUST** have this information:

Model Number (8 to 9 characters): _____

Manufacture Date (mm/dd/yyyy): _____

Replacement Parts List

NOTE: If requested color is not available, similar color will be substituted. Prices are subject to change.

Part	Cost	Qty	Total Cost
Buckle Assembly.....	\$7.99	\$.....
Seat Pad Set.....	\$99.00	\$.....
Chest Clip.....	\$1.50	\$.....
Tether.....	\$6.00	\$.....
Lower Anchor Belt.....	\$17.99	\$.....
Instructions.....	\$0.00	\$.....
Locking Clip.....	\$2.50	\$.....

Merchandise Total: \$.....

Shipping and handling: \$.....

Up to \$25.00.....	\$5.95	\$100.01 to \$150.00.....	\$10.95
\$25.01 to \$50.00.....	\$6.95	\$150.01 to \$200.00.....	\$11.95
\$50.01 to \$75.00.....	\$8.95	\$200.01 and up.....	\$13.95
\$75.01 to \$100.00.....	\$9.95	Outside Continental USA.....	\$10.00

Sales Tax \$.....

(Arizona, California, Georgia, Indiana, Missouri, South Carolina, and Texas residents add applicable sales tax.)

Grand Total \$.....

No shipping and handling on instructions for quantities under 6. Add \$.50 for each instruction over 6, then add applicable shipping and handling.

Fill Out For Credit Card

Visa MasterCard

Card Exp. Date:

Cardholder's Name:

Card Number:

Signature:

Warranty

Dorel Juvenile Group, Inc. (DJG) warrants this product to the original retail purchaser as follows:

This product is warranted against defective materials or workmanship for one year from the date of original purchase. **An original receipt is required to validate your warranty.** DJG will, at its option, provide replacement parts or replace this product. DJG reserves the right to substitute if the part or model has been discontinued.

To make a claim under this warranty you may write to DJG, Consumer Care Department, P. O. Box 2609, Columbus, IN 47202-2609; or call 1-800-544-1108 from 8:00 a.m. to 6:00 p.m. EST Monday through Thursday and from 8:00 a.m. to 4:30 p.m. on Friday.

Proof of purchase is required and shipping charges are the responsibility of the consumer.

Warranty Limitations: This warranty does not include damages which arise from misuse or abuse of this product.

Limitation of Damages: The warranty and remedies as set forth are exclusive and in lieu of all others, oral or written, expressed or implied. In no event will DJG or the dealer selling this product be liable to you for any damages, including incidental or consequential damages, arising out of the use or inability to use this product.

Limitation of warranties and other warranty terms and state law rights:

Any implied warranties, including implied warranties of the merchantability and fitness for a particular purpose, shall be limited to the duration and terms of the express written warranty. Some states do not allow limitations as to how long an implied warranty lasts or the exclusion or limitation of incidental or consequential damages, so the above limitations may not apply to you.

This warranty gives you specific legal rights, and you may have other rights, which vary from state to state. Neither DJG nor the dealer selling this product authorized any person to create for it any other warranty, obligation, or liability in connection with this product.

CUT ON DOTTED LINE